



# Bitumen Partial Upgrading 2018 Whitepaper

**AM0401A**

Alberta Innovates

## **Prepared By**

Bill Keesom, Jacobs Consultancy – Technical Lead

John Gieseman, Jacobs Consultancy – Project Manager

March 2018



Study No: JC158400  
 Document Title: Bitumen Partial Upgrading 2018 Whitepaper - AM0401A  
 Client Name: Alberta Innovates  
 Revision: 6  
 Date: May 11, 2018  
 Study Manager: John Gieseeman  
 Approved by: Robert S. Brasier

**Jacobs Consultancy Inc.**  
**525 W. Monroe, Suite 1600**  
**Chicago, IL 60661**  
**United States**  
[www.jacobsconsultancy.com](http://www.jacobsconsultancy.com)  
[inquiries@jacobsconsultancy.com](mailto:inquiries@jacobsconsultancy.com)

**Document History and Status**

Revision	Date	Description	By	Reviewed	Approved
0	4 Dec 2017		WHK	JCG	
1	8 Dec 2017	Updated figures 5.23, 5.24, 5.25 and Table 5.3 and Updated chapter 4 – Bitumen Fundamentals	WHK	JCG	
2	9-Jan 2018	Included comments from reviewers; moved most of refining and marketing to Appendices	WHK	JCG	
3	26-Jan 2018	Included further comments and changes from reviewers	WHK	JCG	
4	12-Feb-2018	Address further comments and changes from reviewers	WHK	JCG	RSB
5	28-Feb-2018	Address further comments and changes from reviewers	WHK	JCG	RSB
6	2 Mar-2018	Address further comments and changes from reviewers	WHK	JCG	RSB
7	3 Apr-2018	Address further comments and changes from reviewers	WHK	JCG	RSB

*This study or report was prepared by Jacobs Consultancy Canada Inc., (“Jacobs”) for the sole benefit of ALBERTA INNOVATES. There are no third party beneficiaries intended, and none of Jacobs and its affiliates, Alberta Innovates or any of their respective officers, directors, partners, employees, agents shall have any liability whatsoever to third parties for any defect, deficiency, error, or omission in any statement contained in or any way related to the study or report or any related documents. Neither Jacobs nor any person acting on Jacobs’ behalf make any warranty, express or implies, or assumes any liability with respect to use or reliance on any information, technology, engineering or methods disclosed or discussed in the study or report. Any forecasts, estimates, projections, opinions or conclusions reached in the study or report are dependent upon numerous technical and economic conditions over which Jacobs has no control, and which are or may not occur. Reliance upon such opinions or conclusions by any person or entity is at the sole risk of the person relying thereon.*

*The data, information and assumptions used to develop the report or study were obtained or derived from documents or information furnished by others. Jacobs did not independently verify or confirm such information and does not assume responsibility for its accuracy or completeness. Any forecasts, or costs or pricing estimates in the study or report are considered forward-looking statements and represent Jacobs’ current opinion and expectation of a likely outcome. They do not anticipate possible changes in governmental policies, governmental regulations, military actions, embargoes or production cutbacks, regional conflicts, or other events or factors that could cause the forecast or estimates to differ materially from what is contained in our forward-looking statements. The study or report is dated as of the date Jacobs completed its work. Jacobs has no obligation to update or revise the study or report or to revise any opinions, forecasts or assumptions because of events, circumstances or transactions occurring after the date of the study or report.*

## Contents

<b>1.</b>	<b>Executive Summary</b> .....	<b>5</b>
<b>2.</b>	<b>Introduction</b> .....	<b>6</b>
2.1	Definition of Partial Upgrading.....	7
2.2	Incentives for partial upgrading.....	8
2.3	National Partial Upgrading Program.....	10
2.4	Scope of this Whitepaper.....	10
<b>3.</b>	<b>Market Overview</b> .....	<b>12</b>
3.1	Crude Oil Overview.....	13
3.1.1	Crude Oil Characterization.....	13
3.1.2	Yield from Crude Oil Refining.....	15
3.1.3	Greenhouse Gas Emissions from Refining.....	16
3.2	Markets for Canadian Crude Oil.....	17
3.5.1	Classification of US Refining Capability by Geographic Regions.....	22
3.5.2	US Refining Capability to Process Heavy Crude Oils.....	22
3.5.3	Shipment of Crude Oil from Alberta.....	24
3.6	US Markets for Canadian Crude Oil.....	29
3.6.1	20-25 API Gravity Crude Oil Imported into the US.....	33
3.6.2	20-25 API Gravity Crude Oil Imported into PADD1.....	34
3.6.3	Crude Oil Imported into PADD2.....	34
3.6.4	20-25 API Gravity Crude Oil Imported into PADD3.....	35
3.6.5	20-25 API Gravity Crude Oil Imported into PADD4.....	36
3.6.6	20-25 API Gravity Crude Oil Imported into PADD 5.....	37
3.7	Market Opportunities for Alberta Heavy Crude Oils in the US.....	37
3.8	Market Opportunities for Alberta Heavy Crude Oils in Asia.....	40
3.9	Pricing Heavy Crude Oil.....	43
3.10	Other Market Forces Affecting Heavy Crude Oil.....	45
<b>4.</b>	<b>Bitumen and Heavy Oil Fundamentals</b> .....	<b>47</b>
4.1	Bitumen Composition.....	47
4.2	Physical Properties and Dependence on Composition.....	49
4.2.1	Reduction in Bitumen Viscosity.....	50
4.2.2	Reduction in Bitumen Density.....	51
4.3	Market Value – Composition Relationships.....	51
4.4	Processing Reactions to Improve Properties and Market Value.....	52
4.5	Thermal Reactions.....	53
4.5.1	Thermal Cracking.....	53

4.5.2	Addition reactions .....	56
4.5.3	Hydrogen transfer reactions .....	57
4.5.4	Coking .....	58
4.5.5	Scale-up of thermal cracking processes .....	62
4.5.6	Boundaries on thermal cracking .....	62
4.6	Catalytic Cracking .....	64
4.7	Catalytic Hydrogenation .....	64
4.8	Other Catalytic Cycles .....	64
4.8.1	Sodium-Sodium Sulfide Cycle .....	64
4.8.2	Carbon Oxidation-Water Reduction .....	65
4.8.3	Other Process Pathways .....	65
4.8.3.1	Ionizing Radiation .....	65
4.8.3.2	Fluid-Mechanical Alteration.....	66
4.8.3.3	Oxidative Desulfurization .....	66
4.9	Separations to Improve Properties and Market Value .....	67
4.10	Feasible Range of Partial Upgrading Products.....	69
4.11	Combinations of Processes .....	70
<b>5.</b>	<b>Bitumen Partial Upgrading and Technology Readiness.....</b>	<b>73</b>
5.1	Partial Upgrading Overview .....	73
5.2	Upgrading Technology Classification .....	76
5.2.1	Thermal Processing .....	76
5.2.1.1	Visbreaking .....	76
5.2.1.2	Coking .....	79
5.2.2	Asphaltene Rejection .....	82
5.2.2.1	Solvent Deasphalting .....	82
5.2.3	Fluid Mechanical .....	84
5.3	Upgrading Technology Assessment .....	85
5.3.1	Technology Readiness Levels .....	85
5.4	Overview of Potential New Upgrading Technologies .....	86
5.4.1	Thermal Cracking and Coking .....	88
5.4.1.1	Fluid Oil Viscositor .....	88
5.4.1.2	ETX System IYQ Technology .....	89
5.4.1.3	Husky Diluent Reduction (HDR™) Technology .....	90
5.4.1.4	UMATAC Industrial Processes' Alberta Taciuk Retort Process (ATP) .....	91
5.4.1.5	Water-Based Catalytic Visbreaking (Aquaconversion) .....	91
5.4.2	Asphaltene Rejection .....	92
5.4.2.1	Commercial Paraffin Froth Treatment Process Block .....	92

5.4.2.2 Selex-Asp for Rejection of Solid Asphaltene .....	93
5.4.3 Combined Thermal Cracking and Deasphalting .....	94
5.4.3.1 MEG HI-Q® Partial Upgrading Technology .....	94
5.4.3.2 Nexen BituMax™ Partial Upgrading Technology .....	96
5.4.3.3 Water-Based Supercritical Solvent Extraction (JGC) .....	98
5.4.3.4 VCI's ADC and COC Technologies .....	99
5.4.4 Hydrogen Addition and Cracking .....	100
5.4.4.1 Hydrovisbreaking .....	100
5.4.5 Fluid Mechanical .....	101
5.4.5.1 Superior Upgrading Tech./Hammer Technology .....	101
5.4.5.2 Electromechanical Based Technologies .....	102
5.4.5.3 Petrosonic .....	102
5.4.6 Fluid Mechanical and Thermal Cracking .....	102
5.4.6.1 Fractal Systems Jet Shear™/Enhanced Jet Shear™ .....	102
5.4.7 Other technologies .....	105
5.4.7.1 Field Upgrading - Molten Sodium Upgrading.....	105
5.4.7.2 Novel Additive-Based Upgrading .....	106
5.4.7.3 Novel Diluent.....	107
5.4.7.4 Bitumen Solidification.....	107
5.4.7.5 Auterra Oxidative Desulfurization the FlexUP™ Process.....	107
5.4.7.6 In Situ Upgrading .....	107
5.4.7.7 Expander Energy FTCrude® .....	108
5.5 Partial Upgrading Technology Comparisons .....	109
5.6 Partial Upgrading Technology Selection.....	113
<b>6. Summary of Challenges and Recommendations .....</b>	<b>115</b>
6.1 Recommendations for Further Research and Development .....	115
<b>Appendix A: Glossary and List of Acronyms.....</b>	<b>116</b>
<b>Appendix B References.....</b>	<b>123</b>
<b>Appendix C: Petroleum Refining.....</b>	<b>131</b>
<b>Appendix D: US Markets for Imported Crude Oil.....</b>	<b>136</b>
<b>Appendix E. Hydrogen Addition Upgrading Processes.....</b>	<b>155</b>

## 1. Executive Summary

This whitepaper discusses market access for partially upgraded bitumen, the chemistry of bitumen and bitumen upgrading that govern technology choices, and a number of promising partial upgrading technologies. Considerable progress has been made in their development but challenges remain on the path to commercialization. These include: changing market conditions, logistical barriers, mismatch between properties desired by crude oil refiners and achieved by partial upgrading, high capital and operating costs, yield loss, GHG impact, lack of scale, and technical risks. However, multiple pilots, R&D work, and government support are underway to mitigate many of these issues.

The growing supply of Alberta bitumen-derived crude oils must access US refining markets on the US Gulf Coast (USGC), as the Rocky mountain and mid-western refineries are fully supplied with this oil. East coast, Pacific coast, and overseas markets are not easily accessible. Bitumen-derived crude oils from Alberta must compete in the USGC with heavy crude oils from Venezuela and Mexico, which have shorter and lower cost distribution channels.

Most Alberta bitumen-derived crude oils are transported to US refining markets via pipeline. However, pipeline viscosity and density limits require either adding diluent to bitumen or upgrading it to a lighter crude oil. Adding new upgrading capacity to produce synthetic crude oil in Alberta is expensive. Adding diluent is a significant cost. In the second quarter of 2017, diluent used to transport bitumen to the USGC, cost producers nearly US\$14 per barrel of bitumen (US\$14/bbl). Eliminating or reducing diluent would make it less expensive to ship these crude oils from Alberta to markets and make them more competitive with crude oils supplied via blue water. New upgrading technologies have been proposed to address these issues.

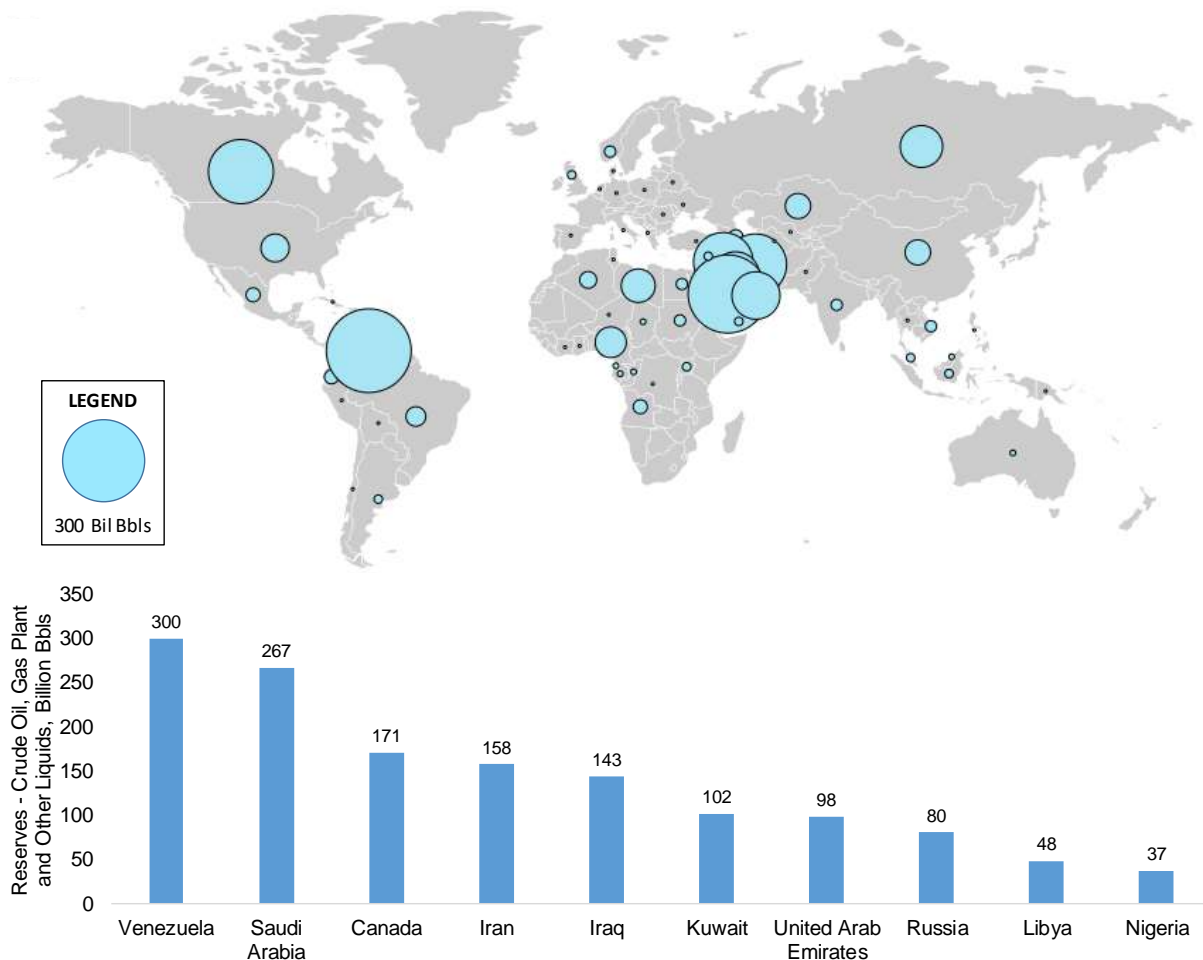
The National Partial Upgrading Program (NPUP) was created to identify technologies that upgrade bitumen to meet the minimum pipeline specifications at a low cost. To achieve these goals, bitumen partial upgrading technologies must convert/reject asphaltenes and convert heavy molecules to lighter ones to reduce or eliminate diluent addition.

Partial upgrading technology developers have approached these requirements in different ways. One approach minimizes cost and maximizes yield by partial conversion of heavy components with no rejection of contaminants. A second approach combines thermal conversion with removal of a portion of the asphaltenes to achieve pipeline specifications and simultaneously improve the value of the partially upgraded product. Due to its low cost, thermal conversion is at the heart of all promising technologies mature enough to consider for demonstration or commercialization. Despite long use in petroleum refinery processing, several aspects of thermal processing remain poorly understood, which may impact the valuation of partially upgraded bitumen-derived crude oils.

## 2. Introduction

Canada contains the third largest crude oil reserves in the world. Figure 1.1 shows the geographic distribution of crude oil reserves, including natural gas plant and other liquid hydrocarbons. Included in Figure 1.1 is a graph from the US Energy Information Administration (EIA) showing reserve estimates for the top ten countries.

**Figure 1.1: Crude Oil and Other Liquid Hydrocarbon Reserves (2016)**



Source (EIA, 2017)

Unfortunately, Canada's major oil production region in Alberta is geographically isolated from world markets and most of its oil reserves are heavy, which require more refining than crude oils from most other top reserve countries with the exception of Venezuela and Mexico. Refining Canadian bitumen and heavy crude oil in the country for domestic use and for export is limited by insufficient clean-fuel pipeline capacity for transport of refined products and the high cost of building new refining capacity in Canada. As a result, bitumen and heavy oil production from

Alberta and Saskatchewan is exported to existing petroleum refineries outside of Canada. Capacity expansion at existing refineries in distant markets is less expensive than building new greenfield refining capacity in Canada.

The most cost effective high volume mode for transporting crude oil over land is by pipeline and most Alberta bitumen moves on the existing pipeline network. Viscosity maxima and API gravity minima are specified by pipeline companies to ensure efficient operations and maximize movement of heavy oil from Alberta. Table 1.1 lists the current specifications for pipeline transportation, and the corresponding properties of bitumen. To satisfy these specifications, Alberta bitumen must be diluted by a lighter material, which reports as a cost to the bitumen producer. Diluents are primarily light naphtha, natural gas condensate, or synthetic crude oil, produced from upgrading bitumen. When bitumen is diluted with condensate it is called dilbit and with synthetic crude oil (SCO), synbit.

**Table 1.1 Pipeline Specifications and Representative Alberta Bitumen Products**

Property	Specification	Athabasca bitumen	Diluted bitumen from in situ production <sup>1</sup>	Synthetic crude oil (SCO) <sup>2</sup>
Viscosity	maximum 350 centistokes (cSt) at pipeline temperature	5000 to 300,000 cSt at 25 °C	209 cSt at 15°C	8 cSt at 15°C
Density, kg/m <sup>3</sup>	< 940	1015	922.1±5.1	863.3±4.4
Gravity °API	>19	7.9	21.8±0.8	32.3±0.8
Bottom solids and water	< 0.5 vol%	0-2%	< 0.1%	0
Olefin content	< 1 wt%	0	0	0

Notes:

1. Access Western Blend (AWB), a heavy, high TAN dilbit produced by Devon Energy Canada and MEG Energy Corp, five-year average from the ( (Crude Monitor, 2017))
2. Syncrude Sweet Premium, a light sweet synthetic crude produced from the Syncrude Canada, five-year average from ( (Crude Monitor, 2017))

## 2.1 Definition of Partial Upgrading

Bitumen upgrading removes contaminants and can reduce or eliminate the need to add diluent to meet pipeline specifications for viscosity and density. There is a continuum of possible product properties, starting from bitumen and ranging to synthetic crude oil (SCO) and beyond (Table 1.1). The original upgraders were built in Alberta because the bitumen from mining contained too much



bottom sediment and water (BS&W) and therefore could not be transported by pipeline. The products from these plants in Fort McMurray can be considered “full upgrading” to produce a range of blended and easily-transported synthetic crude oil products with a significantly higher price than diluted bitumen. In contrast, the bitumen produced by in situ methods from Athabasca, Cold Lake, and Peace River are blended with diluent to produce a pipeline-able, fungible product, without requiring any investment in an upgrader. Diluent is typically condensate or synthetic crude oil. Condensate diluent is typically around 30 volume percent (vol%) or more in a diluted bitumen (dilbit) blend like AWB. SCO diluent may be as high as 50 vol% in the synbit blend. Development of paraffin froth treatment has enabled mined bitumen to be blended with diluent and transported via pipeline.

Partial upgrading is defined for the purpose of this whitepaper as any combination of bitumen processing steps and reduced diluent addition to meet the specifications for pipeline transport, listed in Table 1.1. Although a range of products between the pipeline specification and fully upgraded SCO can be produced, and might be profitable, they are not considered in this whitepaper. Here we consider partial upgrading of bitumen to meet pipeline specifications with no or reduced diluent addition. At present, no partial upgrading plants are in operation, and no fully commercial technologies are available that make partial upgrading a feasible investment.

## 2.2 Incentives for partial upgrading

While the majority of bitumen from oil sands mining is upgraded, very little bitumen from in situ production is upgraded in Alberta and Saskatchewan. A study by the University of Calgary School of Public Policy, published in 2017 (Fellows, et al., 2017), highlighted the significant potential opportunity for benefits both to the oil sands industry and to the Provinces of Alberta and Saskatchewan through increased investment and employment in value-added manufacturing.

The existing facilities for full upgrading of bitumen are complex and expensive to build and operate. The capital cost of the Suncor Voyageur Upgrader, at the time of its cancellation in 2013, was estimated at \$11.5 billion, for a cost per flowing barrel of approximately \$60,000/(bbl/day) (Jang, 2017). The costs to install new capacity in Alberta have escalated, diminishing economic and financial incentives to build new capacity for SCO production. At the same time, using diluent or SCO to meet pipeline specifications for transporting bitumen is expensive and takes up pipeline capacity. To ensure market access for Alberta bitumen, a new approach to upgrading is required that optimizes the amount and type of processing that is performed. New technology and combinations of technologies for *just enough* partial upgrading of bitumen to meet pipeline specifications and minimize downstream processing should reduce costs overall.

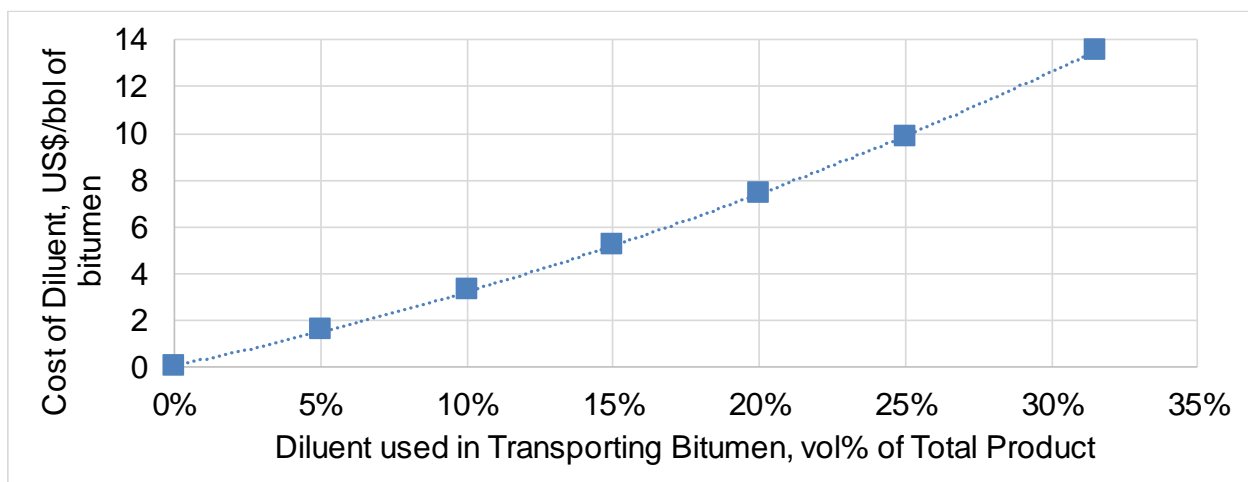
Transporting bitumen to refineries in pipelines requires blending with 30 volume percent (vol%) or more of condensate to meet pipeline viscosity specifications. Transporting bitumen as a diluted

bitumen (dilbit) blend reduces the amount of pipeline capacity available to ship bitumen as some capacity is used by the diluent. At the refinery, the diluent in dilbit can be separated and returned to Alberta, refined to gasoline, or sold as a petrochemical feedstock. However, the high vapor pressure of the light condensate diluent, limits its use as a gasoline blendstock in the US in summer when gasoline vapor pressure is restricted. Ultimately adding diluent to bitumen to enable pipeline transport becomes a significant cost to producers (around US \$14/bbl of bitumen in the second quarter of 2017 – this includes loss incurred by the difference in price between the cost of diluent and the price diluent sells for as dilbit and the cost of transporting diluent in dilbit).

The following figure illustrates significant financial benefit from reducing diluent use. The basis is a dilbit containing 31.5 vol% diluent. Prices are second quarter 2017 with the following assumptions:

- Pipeline tariff from Hardisty to the US Gulf Coast via the Enbridge pipeline system - \$US 7.79/bbl
- Pipeline tariff from the in situ production site to Hardisty - \$C 1.85/bbl
- Exchange rate is 1.3 CAD/USD
- Condensate diluent is priced at \$C 71/bbl at Edmonton
- Dilbit is priced at \$US 37.18/bbl at the US Gulf Coast
- No benefit taken for any bitumen quality improvements
- Products meet pipeline specifications.

Figure 2.1: Cost of Diluent in Transporting Bitumen\*



\*Assumes diluent price of US\$56/bbl at production site; dilbit price of US\$35.8 at USGC; and pipeline tariff of US\$9.2/bbl from production site to USGC. Quality changes from partial upgrading are not considered in this figure.

## 2.3 National Partial Upgrading Program

The National Partial Upgrading Program (NPUP) was initiated in 2015 by Alberta Innovates (AI) and the CANMET Energy Laboratories of Natural Resources Canada. Oil sands producers were invited to join an Advisory Committee to work on a range of collaborative projects. NPUP's vision is that Canadian bitumen and heavy oil are purchased and valued globally as cost competitive and environmentally attractive. NPUP's mission is to accelerate innovation for partial upgrading of bitumen and heavy oil to:

- Reduce or eliminate the use of diluent for pipeline transport
- Improve oil product quality and mitigate by-products
- Increase overall resource value and market access
- Reduce environmental impacts

It is the view of NPUP that commercially available technologies may not fit current needs of the bitumen production industry. As a result, participants in the NPUP Advisory Committee are working together to identify, investigate, and reduce the risk of the most promising pre-commercial partial upgrading solutions. The scope of NPUP is to investigate market, policy, and technology opportunities and challenges to support development and commercialization of partial upgrading solutions in Canada. Current industry members are Cenovus, Canadian Natural, Husky, MEG Energy, Nexen, and Suncor. Government members are Alberta Innovates, Alberta Energy, CANMET and the Saskatchewan Ministry of Economy.

## 2.4 Scope of this Whitepaper

The objective of this whitepaper is to provide a comprehensive document to inform and guide NPUP and help accelerate targeted innovations in partial upgrading of bitumen.

The specific objectives of this Whitepaper are to:

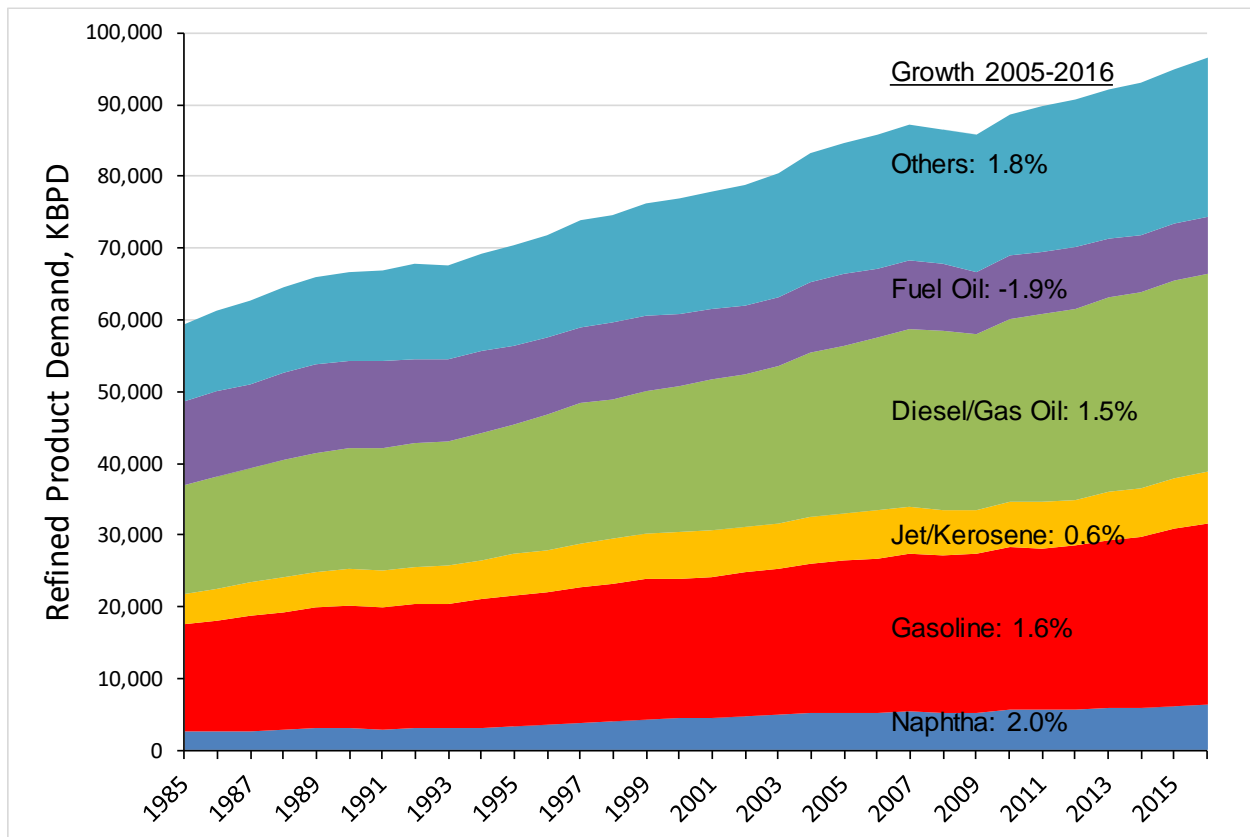
- A. Provide a global market perspective and opportunities for bitumen partial upgrading products (Chapter 3 Market Overview). The opportunities for market expansion and improved pricing determine which partial upgrading technologies will give the highest benefit.
- B. Provide a summary of bitumen and heavy oil chemistry (Chapter 4). The chemistry of bitumen determines what changes will deliver product that meets pipeline specifications and defines the technical boundaries of partial upgrading.
- C. Review technologies that have been proposed for partial upgrading, and assess their technology readiness levels and ability to meet the pipeline specifications (Chapter 5).

- D. Summarize the key characteristics of bitumen partial upgrading products (Chapters 4 and 5)
- E. Identify critical challenges and gaps remaining for commercializing bitumen partial upgrading solutions and maximizing the value of partially upgraded products (Chapter 6).
- F. Make recommendations for research and development to overcome challenges and close gaps for the National Partial Upgrading Program (Chapter 6).

### 3. Market Overview

Most crude oil is refined to light transportation fuels: gasoline, jet fuel, and diesel. Crude oil is a source for heavy fuel oil used in power production, industrial use, and as bunker fuel for ships. It is also a source of petrochemical feedstocks. Figure 3.1 shows the trend in worldwide demand for refined products from crude oil since 1985. Annual growth for each major product since 2005 is also shown on this figure. The category 'Others' consists of refinery gas, liquefied petroleum gas (LPG), solvents, petroleum coke, lubricants, bitumen, wax, other refined products, and refinery fuel and loss. Demand growth for most products is correlated with economic and population growth. Fuel oil demand is falling because of replacement by other fuels – natural gas and because of greater conversion of heavy residue in crude oil to more valuable lighter products.

Figure 3.1: Worldwide Growth in Products from Crude Oil Refining



\* (BP, 2017) Residue or resid are the common abbreviations for residuum or residual fuel oil which is the heaviest oil and recovered from the bottom of a refinery vacuum column. We will use the term residue throughout this paper.

### 3.1 Crude Oil Overview

Market demand for refined products is met by petroleum crude oil refineries that convert crude oil's wide range of molecules into products. Refineries first distill crude oil into fractions that are further processed by making the molecules smaller, adding or rearranging hydrogen and removing impurities. The extent of refining depends on crude oil quality and the processing capability of the refinery.

In general, lighter crude oils contain less sulfur, nitrogen, metals, and micro-carbon residue (MCR) and require less processing than heavier crude oils to meet finished product quality specifications and demand. However, light, low sulfur, nitrogen, metals, and MCR content crude oils are more expensive than heavier crude oils. Finally, refining configurations are optimized to meet market demand for refined products within a fairly narrow range of crude oil properties. A refinery optimized to process a heavy crude oil slate may be sub-optimized when processing a light crude oil slate and vice versa.

#### 3.1.1 Crude Oil Characterization

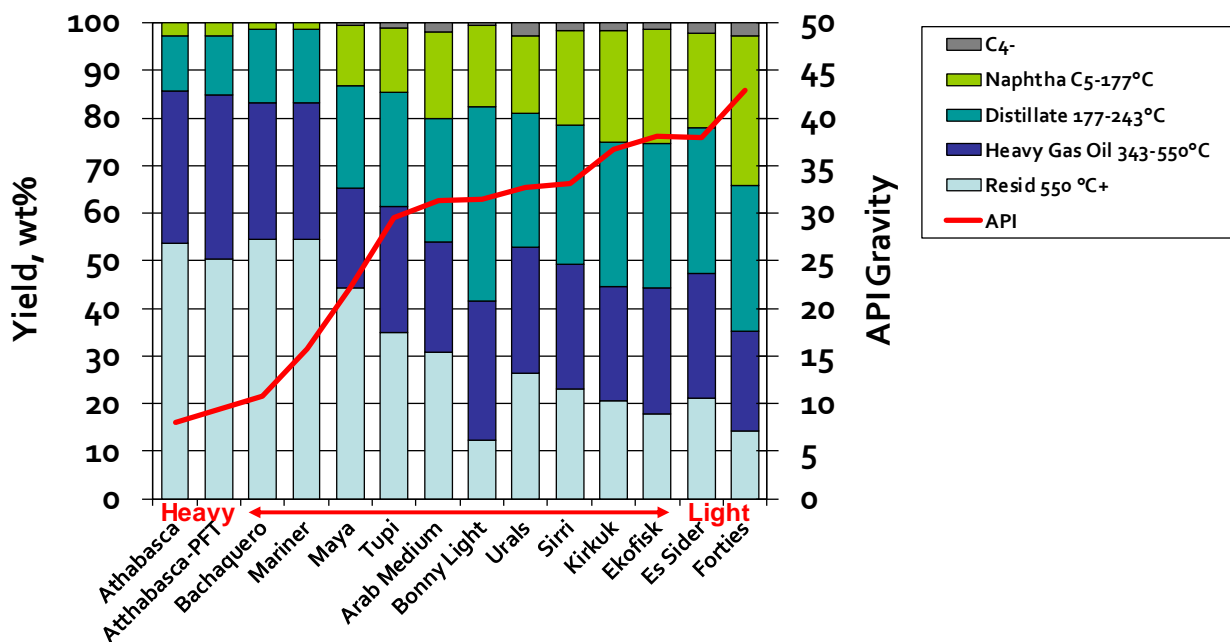
Crude oils are characterized for petroleum refining by API gravity, amount of sulfur, nitrogen, MCR and total acid number (TAN), as well as the yield of typical products like naphtha, distillate, heavy gasoil, that can be distilled from the crude oil and the vacuum residue, that is too heavy to distill. The acidic compounds that contribute to TAN corrode refining equipment and refiners will either improve the metallurgy in their equipment to enable processing of high TAN crudes or offset high TAN with low TAN crudes. TAN is a barrier to processing crude oil but does not affect refining yield as do sulfur, nitrogen, metals, MCR, and crude oil API gravity.

Figure 3.2 shows the amount of butane and lighter hydrocarbons ( $C_4^-$ ), naphtha, distillate, heavy gasoil, and vacuum residue for a range of crude oils. Naphtha is a rough surrogate for gasoline. Distillate is used to produce diesel and jet fuel. Heavy gasoil is typically converted to lighter fuels via refining. Vacuum residue is undistillable material that can end up in heavy fuel oil and bunker fuel or it can be converted to lighter fuels via further refining. Light crude oils yield more naphtha, gasoline, jet fuel, and diesel fuel with less refinery processing than heavy crude oils, which contain more vacuum residue.

Crude oils in Figure 3.2 are sorted from lowest to highest API gravity—in other words, from heaviest crude to lightest crude. In this figure we see that crude oils fall on a continuum. Bachaquero is slightly lighter than Athabasca bitumen (higher API gravity) yet has similar yield of residual material, heavy gasoil and naphtha. Based on this assay, it is expected that the refining configuration and yields from Bachaquero would be similar to those needed to process Athabasca bitumen.

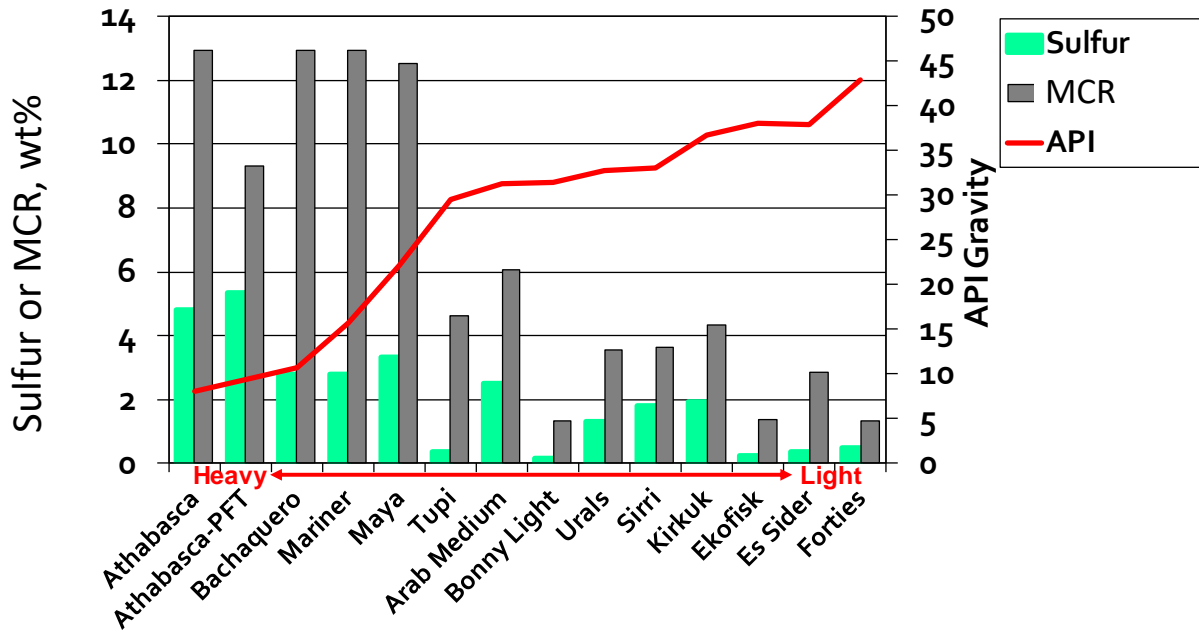
Figure 3.3 shows that refractory carbon, measured as MCR, correlates with the amount of vacuum residue (Figure 3.2). Lighter crudes contain less residue and less MCR. Sulfur has a less pronounced correlation with crude API than does MCR. The heavy crude oils, Bachaquero, Maya, and Athabasca bitumen have similar amounts of MCR, which means they contain similar amounts of refractory, hard to convert carbon-rich components and will require similar heavy crude bottoms conversion capability.

Figure 3.2: Yield by Boiling Point for a Range of Crude Oils. (Resid is vacuum residue)



(Haverly Chevron Crude Assay Library - with Jacobs Analysis, 2016)

Figure 3.3: Micro Carbon Residue (MCR) and Sulfur Content for a Range of Crude Oils.



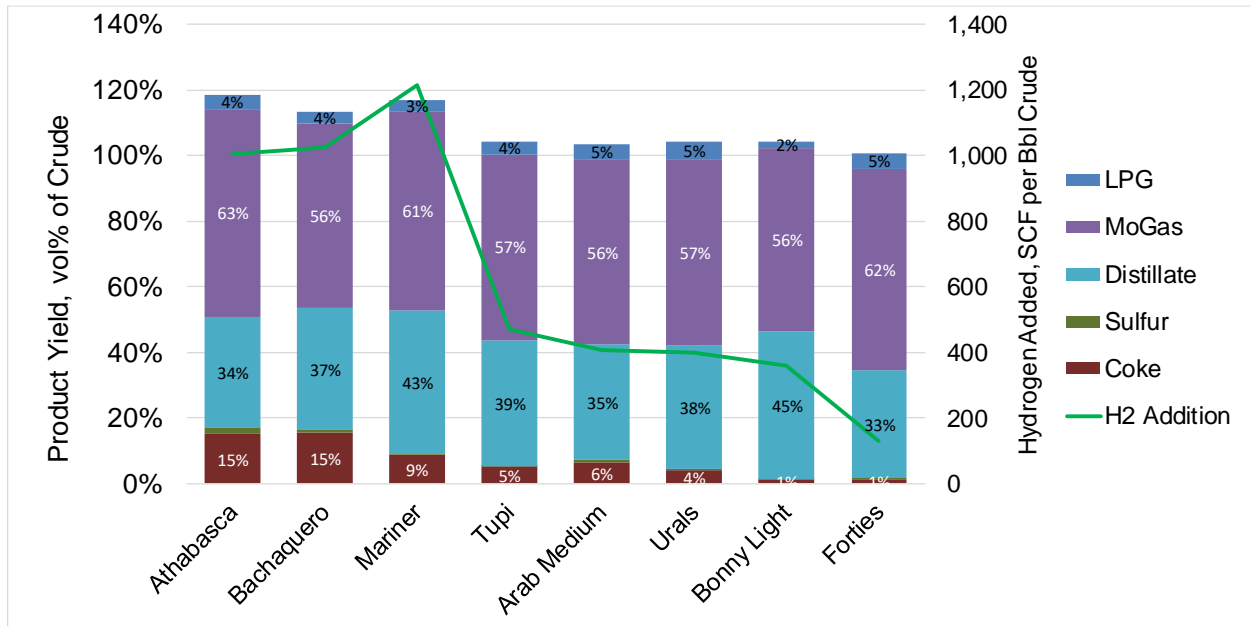
(Haverly Chevron Crude Assay Library - with Jacobs Analysis, 2016)

### 3.1.2 Yield from Crude Oil Refining

Petroleum refineries combine a range of processes in order to convert crude oils into transportation fuels or other valuable products. Further details on refinery processes are given in Appendix C. The value of a crude oil to a refinery is related to the yield of products that can be achieved. Figure 3.4 shows the yield of major refined products as a percent of crude oil from a high conversion refinery designed to maximize light transportation fuel. Sulfur and petroleum coke have been converted to barrels of fuel oil equivalent.



Figure 3.4: Product Yield from Refining a Range of Crude Oils to Maximize Light Transport Fuels



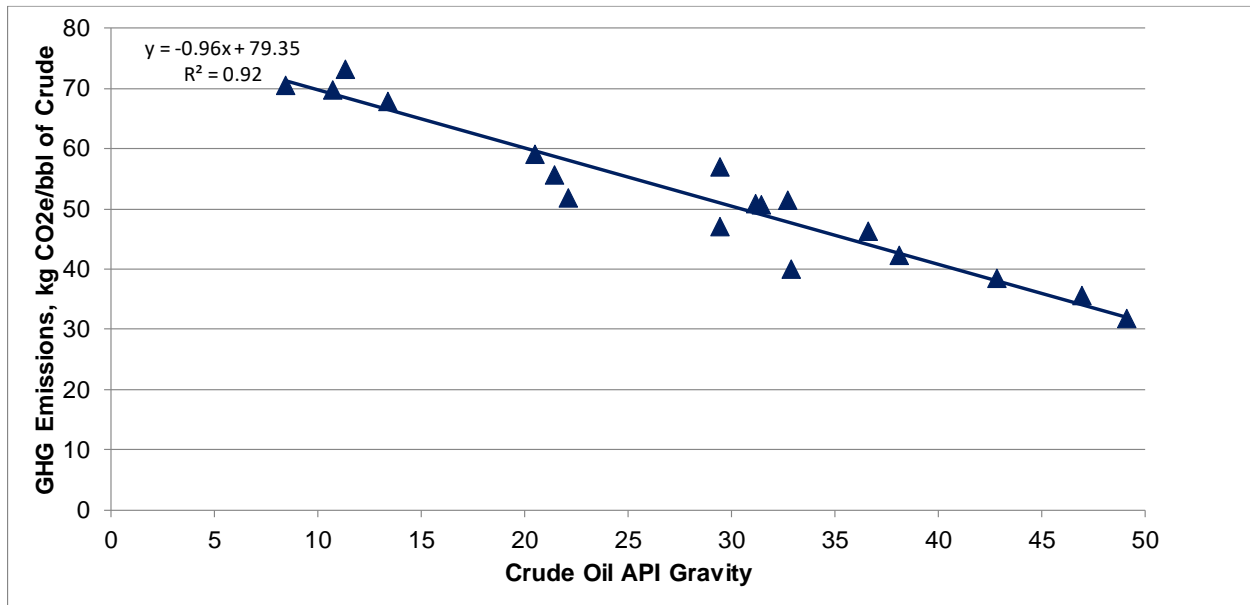
(JacobsConsultancy, 2012)

Higher yield of refined products from a barrel of crude oil is achieved with heavy crude oils as a result of greater hydrogen and isobutane addition in the refining process.

### 3.1.3 Greenhouse Gas Emissions from Refining

The energy required to refine crude oils depends on the API gravity of the crude oil, the extent of conversion desired, and the refinery configuration (JacobsConsultancy, 2012). Figure 3.5 shows how the GHG emissions from refining, which are highly correlated with energy consumption, decrease as the crude oil API gravity goes up (density goes down) (Jacobs Consultancy, 2016). These data are from modeling the conversion, yield, energy consumption, and GHG emissions from refining different crude oils in a coking based, high-conversion refinery that maximizes the production of light transportation fuels (gasoline, jet fuel and diesel fuel). The capacity of the process units in this refinery are allowed to change to match crude oil composition and assay. Energy consumption and process unit yields are consistent with refining industry experience (JacobsConsultancy, 2012). Further details on oil refining is in Appendix C.

Figure 3.5: GHG from Crude Oil Refining – Coking Based, High-Conversion Refinery

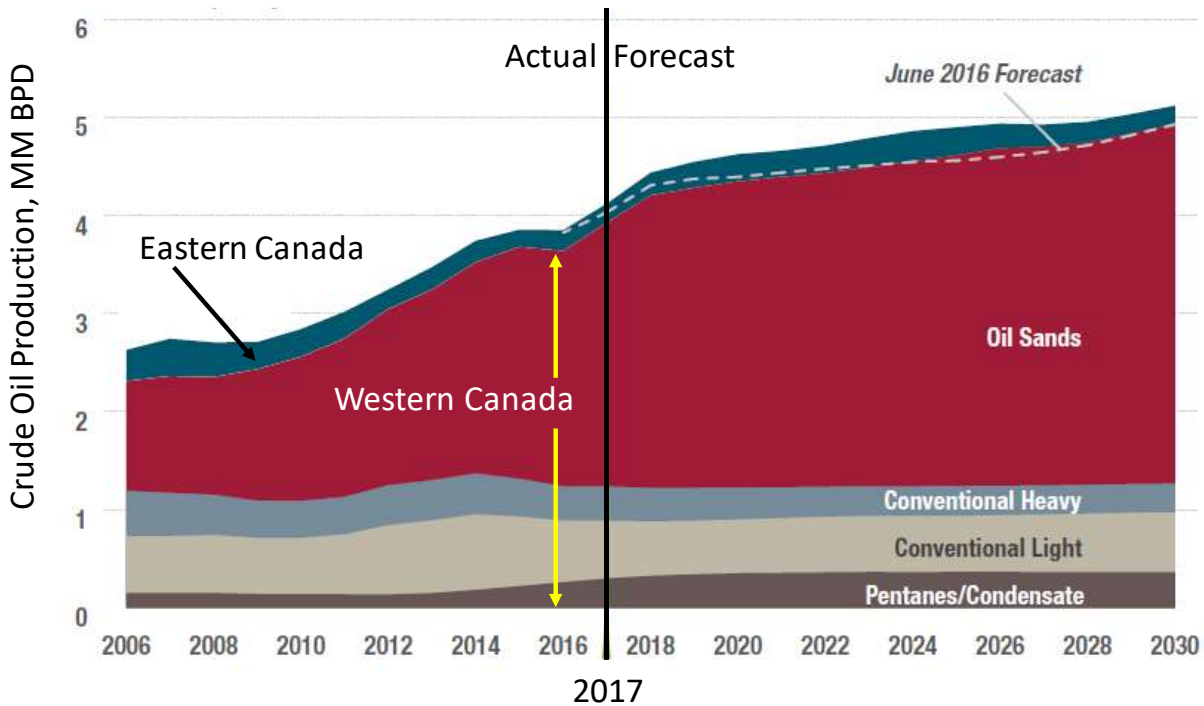


(Jacobs Consultancy, 2016)

### 3.2 Markets for Canadian Crude Oil

Most Canadian crude oil comes from Western Canada and most is from the oil sands region in Alberta, which produces bitumen and SCO. Figure 3.6 shows historical production of crude oil in Canada and projected production to 2030 from the Canadian Association of Petroleum Producers (CAPP, 2017). CAPP forecasts that Western Canada will increase bitumen crude oil production by 1.3 MM BPD from 2016 to 2030. This forecast from CAPP is more optimistic than the one in June 2016, which considered lower crude oil prices and the impact of wildfires around Fort McMurray in Alberta, the major oil sands production area.

Figure 3.6: Historical and Forecast Crude Oil Production in Canada



(CAPP, 2017)

Table 3.1 shows Canadian crude oil production in 2016. Western Canada produced around 2.4 MM BPD of oil sands based crude oil in 2016 (including bitumen that was upgraded to SCO).

Table 3.1: 2016 Crude Oil Production in Canada

	Conventional	Pentanes and Condensate	Oil Sands*		Total Crude Oil
			Mined	In Situ	
	KBPD	KBPD	KBPD	KBPD	
Eastern Canada	213				213
Western Canada					
Manitoba	40	0			40
Saskatchewan	459	0			459
Alberta**	440	220	1,030	1,370	3,060
British Columbia	23	38			61
Subtotal Western Canada	962	258	1,030	1,370	3,620
Total Canada	1,175	258	1,030	1,370	3,833

(CAPP, 2017)

\* Bitumen sent to market, which includes bitumen that has been upgraded (mostly from mined bitumen).

\*\* Bitumen is produced primarily in Alberta. However, some is from Saskatchewan, which is not broken out in this table; bitumen reported here is as if all is from Alberta.

According to CAPP, in 2016 Canada consumed around 1 MM BPD of Canadian crude oil (Table 3.2).

**Table 3.2: 2016 Crude Oil Consumption in Canada**

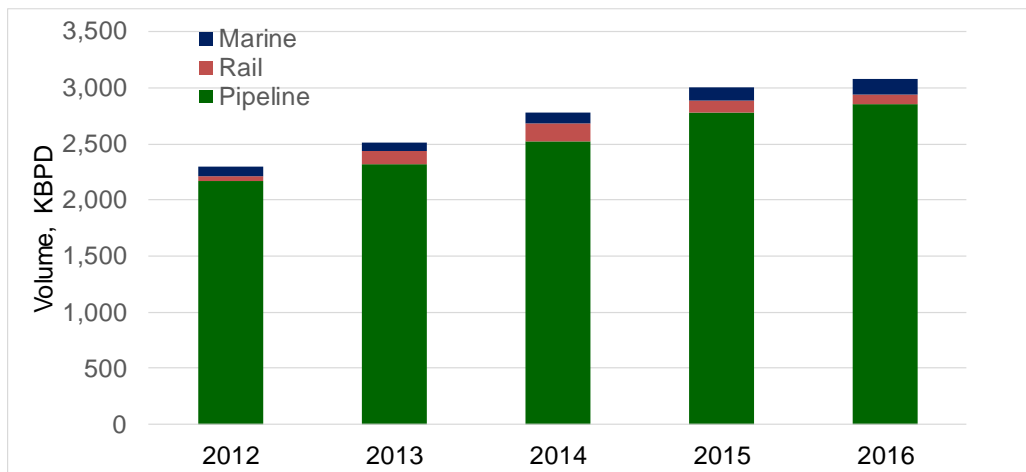
	Refineries	Processing Capacity	Crude Processed	Canadian Crude Oil Processed		Imported Crude
				Western Canada	Eastern Canada	
		KBPD	KBPD	KBPD	KBPD	KBPD
Eastern Canada	8	1,200	1,047	264	202	581
Western Canada	8	683	553	553	0	0
Total	16	1,883	1,600	817	202	581

(CAPP, 2017)

### 3.3 Transport of Canadian Oil

Most Canadian crude oil is exported to the US. According to the Canadian National Energy Board, (NEB) approximately 1% of crude oil exports went to countries that were not the U. S (National Energy Board, 2017). Figure 3.7 shows transport modes from 2012-2016 for Canadian crude oil. These data are reported in m<sup>3</sup>/yr. and were converted to KBPD by assuming 365 days per year. Most Canadian crude oil is delivered by pipeline. Delivery by rail is a small transport mode, but may increase if new pipeline capacity is not added.

**Figure 3.7: Mode of Crude Oil Transport from Canada**

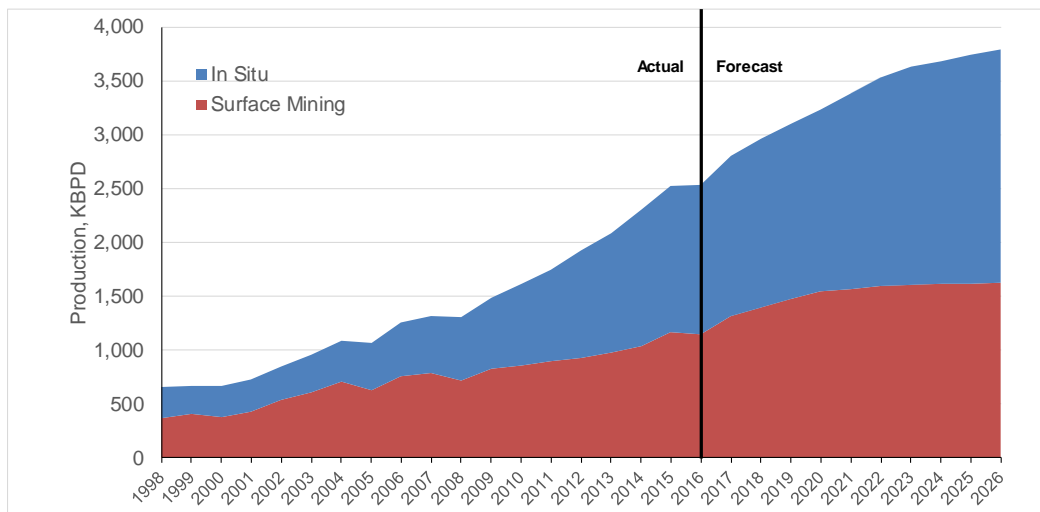


(National Energy Board, 2017)

### 3.4 Alberta Bitumen Production

The Alberta Energy Regulator (AER) reports that Alberta produced 1,390 KBPD of bitumen via in situ methods and 1,150 KBPD of bitumen via mining in 2016 (Alberta Energy Regulator, 2017). Most bitumen production growth is forecast by AER to be from in situ production. By 2026, the AER projects in situ production will grow to 2,170 KBPD and mined bitumen will grow to 1,620 KBPD for a total growth in bitumen production of around 1,250 KBPD from 2016, which is higher than the 1,020 KBPD forecast by CAPP for this period. AER’s historical and forecast for bitumen production are shown in Figure 3.8.

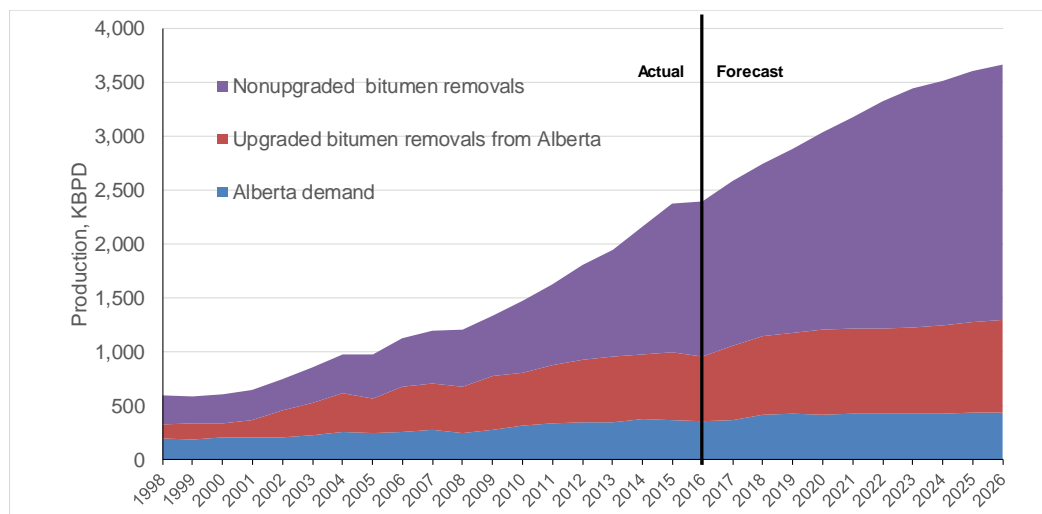
**Figure 3.8: Alberta Bitumen Production – Historical and Projected**



(Alberta Energy Regulator, 2017)

Historical and forecast disposition of bitumen are shown in Figure 3.9. Demand for bitumen in Alberta is projected to grow by 2% from 2016 to 2026. Export of upgraded bitumen (SCO) is projected to grow by 3.7% while export of non-upgraded bitumen is projected to grow by 5.1% over this period. As we will discuss further in this section, it will be challenging to find a market for this additional crude oil in North American refineries.

Figure 3.9: Alberta Bitumen Disposition – Historical and Projected



(Alberta Energy Regulator, 2017)

Non-upgraded bitumen requires diluent for transport in pipelines. Pipeline specifications require crude oils transported from Alberta be less than 350 centistokes (cSt) in viscosity with density less than 940 kg/m<sup>3</sup> (greater than 18.9 API gravity) with no detectable olefins by hydrogen nuclear magnetic resonance (HNMR) measurement (the detection limit by this method is 1 wt%) and bottoms sediment and water (BS&W) less than 0.5 vol%. Condensate (30% vol% or more) is added to bitumen to meet these specifications, producing dilbit which is transported by pipeline.

Fully upgraded bitumen (SCO) has been processed to reduce viscosity, sulfur, TAN, MCR, and density (increase in API). Many SCOs are in the range of 830 to 870 kg/m<sup>3</sup> (30-38 API). (Crude Monitor). SCO competes with the growing shale oil supply from the US and with West Texas Intermediate (WTI) types of crude oil used in refineries that have limited or no capacity for converting and refining vacuum residue in the crude oil.

The primary target for partially upgraded bitumen is to economically meet the pipeline specifications with reduced or no diluent addition. Product quality improvement is a side benefit of meeting pipeline specifications while some entities treat it as another goal of partial upgrading.

### 3.5 Access to Markets for Alberta Heavy Crude Oils

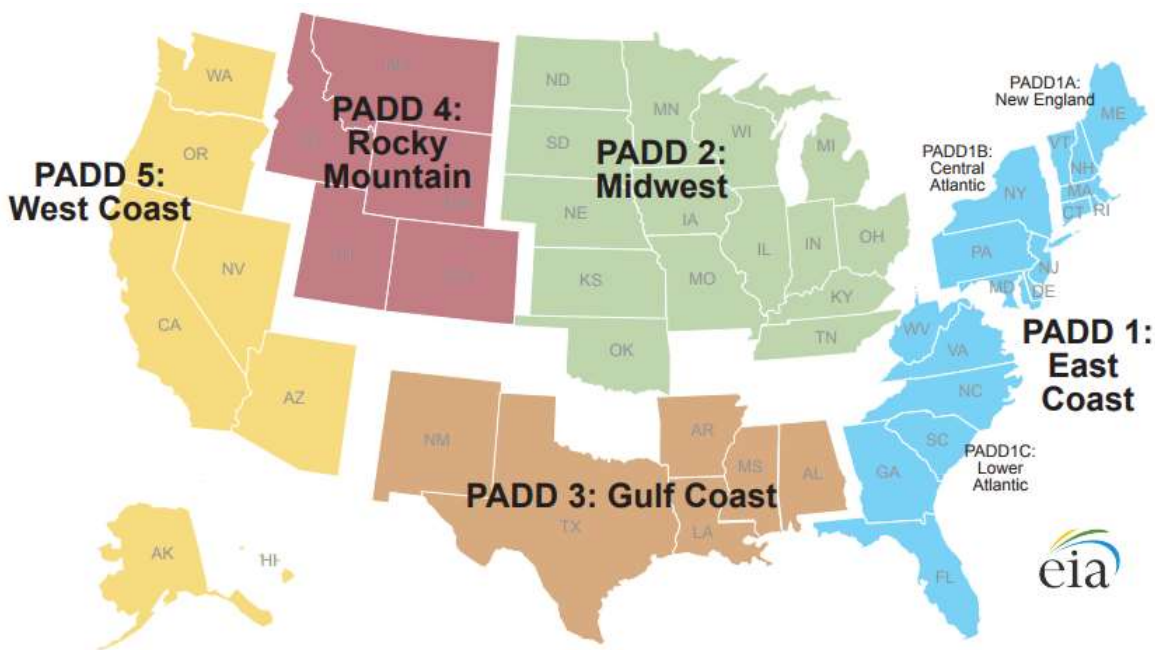
Market access for crude oils from Alberta is primarily via pipeline to the US. As we will discuss subsequently in more detail, most Alberta crude oil has historically gone into the US Midwest and Rocky Mountain regions. Access to the US Gulf Coast has only occurred in the last few years.

We now provide a brief overview of the US market to better understand opportunities for Alberta crude oils.

### 3.5.1 Classification of US Refining Capability by Geographic Regions

The US government divides the US into different geographic regions called Petroleum Administration Districts for Defense (PADD), shown below in Figure 3.10.

Figure 3.10: US PADDs

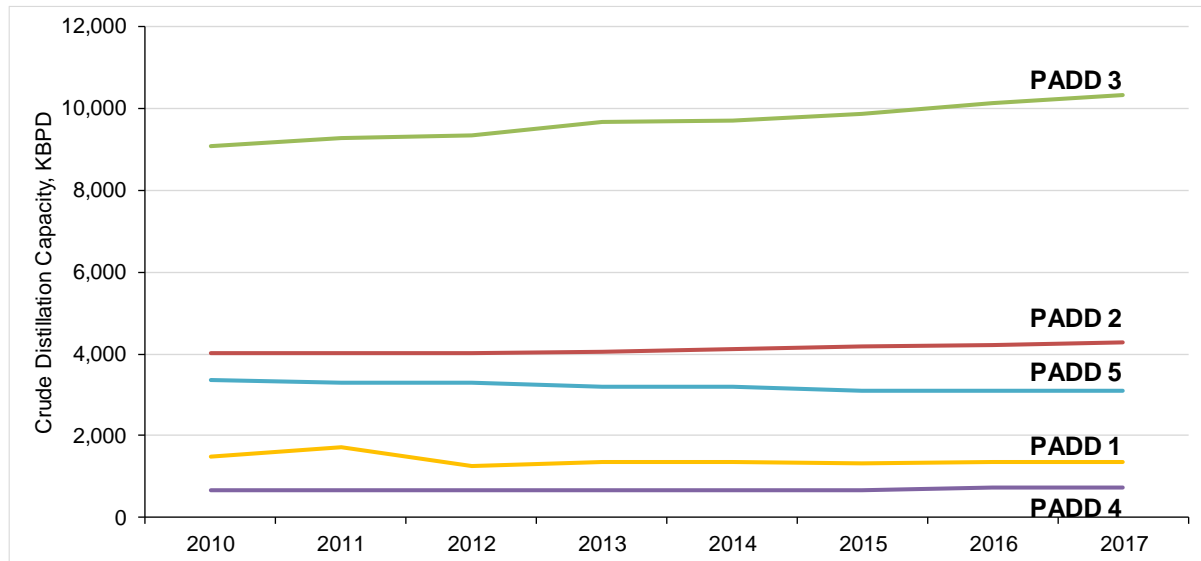


(EIA-2, 2017)

### 3.5.2 US Refining Capability to Process Heavy Crude Oils

Refining capacity is often expressed as amount of atmospheric distillation unit capacity. Trends in US refining capacity by PADD are shown in Figure 3.11. PADD 3 has the most crude oil refining capacity followed by PADD 2 and then PADD 5. PADD 4 has the smallest crude oil refining capacity. PADD 1, which has greater population than any other PADD, has the second smallest refining capacity. Refined products move by pipeline between PADD 3 and PADD 1 and PADD 3 and PADD 2. There is not much movement of refined products from other PADDs to PADDs 4 and 5. There is little movement of product from PADD 2 to PADD 1. These data show little or no change in crude oil distillation capacity in PADDs 2 and 4. A slight decline in PADDs 1 and 5 and a slow increase in crude oil distillation capacity in PADD 3.

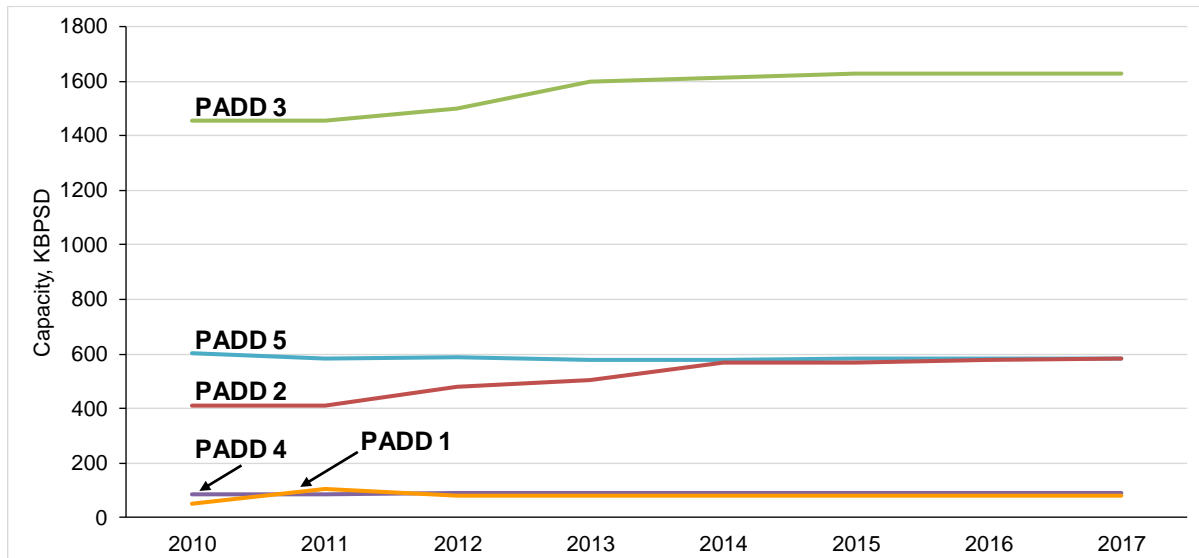
Figure 3.11: US Refining Capacity by PADD – Atmospheric Crude Unit Capacity



(EIA-3 Plotted by Jacobs, 2017)

Processing heavy crude oils to maximize light transportation fuels, requires bottoms conversion. Coking is the most common type of bottoms conversion in US refineries. Figure 3.12 shows the change in coking capacity in US refineries over time. PADDs 2 and 3 have added coking capacity. PADD 1 has seen a small increase in coking capacity. PADDs 4 and 5 have seen little change in coking capacity.

Figure 3.12: Coking Capacity by US PADD

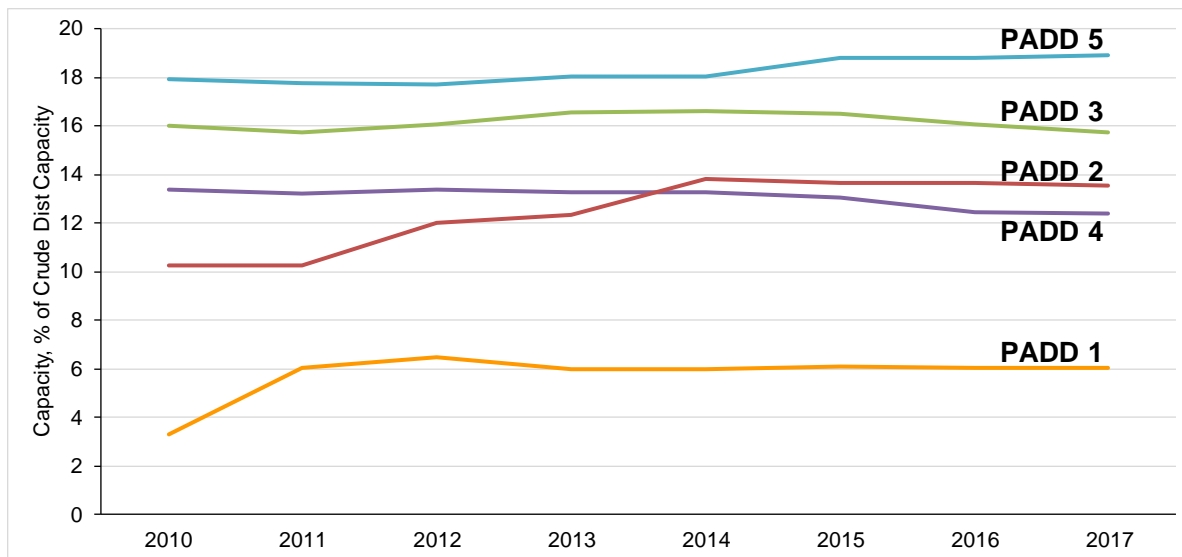


(EIA-3 Plotted by Jacobs, 2017)



Figure 3.13 shows the distribution of coking capacity as a percent of atmospheric crude oil distillation capacity in different US PADDs. PADD 5 has the most coking capacity as a percent of crude oil distillation capacity. PADD 1 has the least. PADD 2 has added coking capacity to process heavier crude oils. PADD 4 has similar coking capacity as percent of crude distillation capacity as PADD 2. The apparent growth in coking capacity as a percent of crude distillation capacity in PADD 5 is mainly a result of reduced crude distillation capacity.

**Figure 3.13: Coking Capacity– as Percent of Crude Distillation Capacity**



(EIA-3 Plotted by Jacobs, 2017)

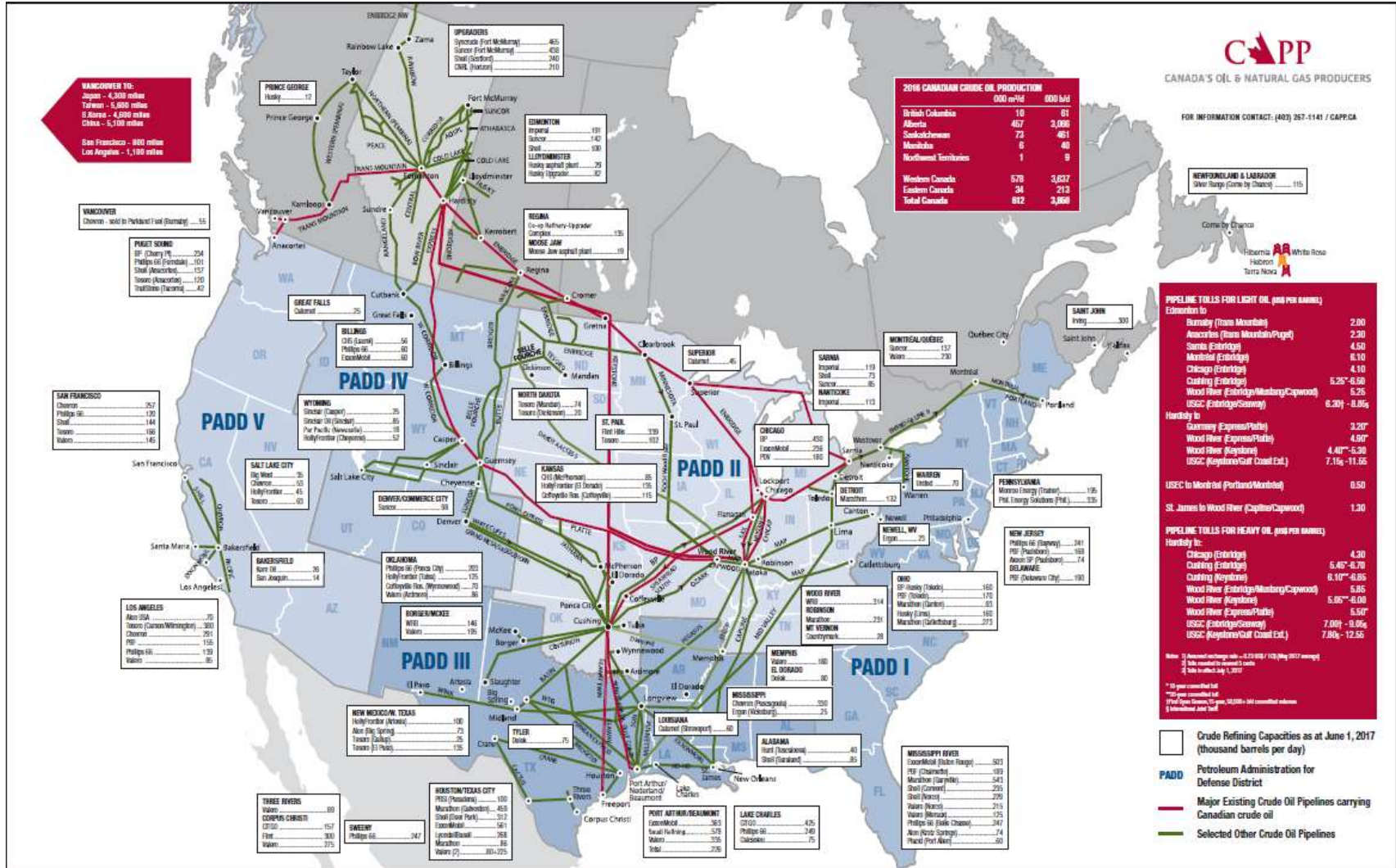
### 3.5.3 Shipment of Crude Oil from Alberta

PADDs 2 and 4 have been supplied with Alberta crude oil for some time via pipeline. Access to the US Gulf Coast (PADD 3) has been established in the last few years and additional pipeline transport capacity is likely. There is limited access to the Canadian West Coast near Vancouver, which limits access to PADD 5. There is no access for Alberta crude oils to the Canadian East Coast via pipeline. Plans for new pipeline capacity to either Canadian coast are on hold. Kinder Morgan is in the process of final approval for its Trans Mountain pipeline expansion from the industrial heartland of Alberta to Burnaby, BC, which will triple its capacity to 890 KBPD. (Gordon, 2018)). Figure 3.14 shows the pipeline map of Canada and the US. (CAPP-2, 2017)

Rail is another option for transporting heavy crude oil from Alberta. It is more expensive and not a major transportation route for Canadian crude oil in the US. Figure 3.15 shows Canadian crude oil transport to the US since 2012. Figure 3.16 shows transport of Canadian crude oil to PADD 2 and Figure 3.17 shows transport of Canadian crude oil to PADD 3. There is little crude oil transport by rail to PADDs 1,4, or 5. These data are from the EIA, and do not report from where in Canada

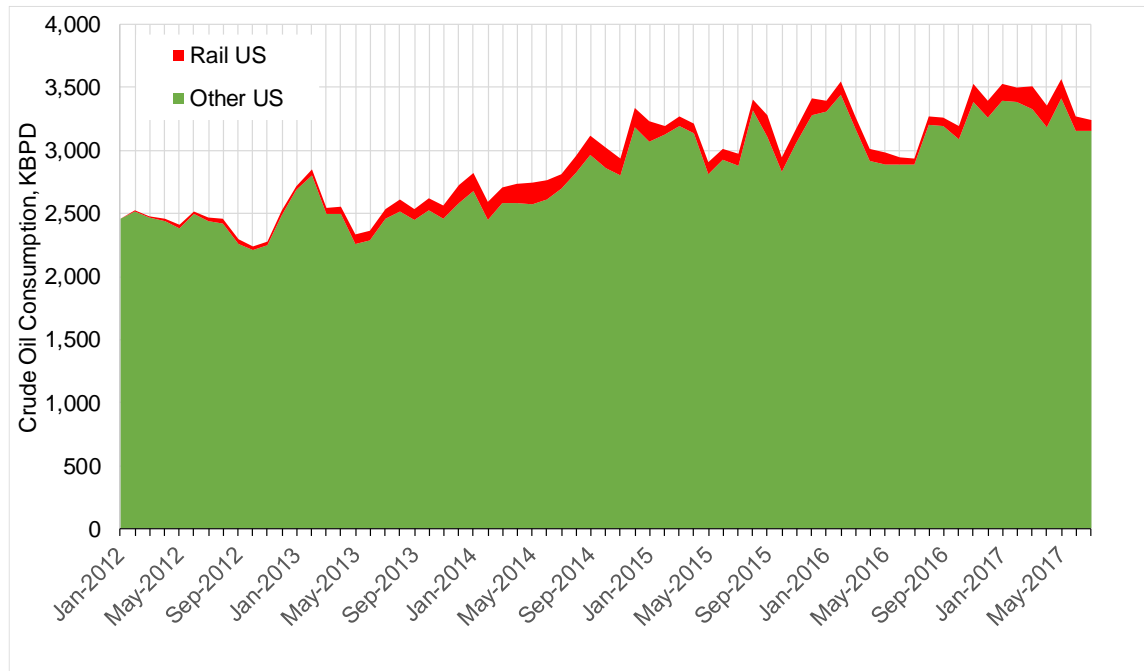
the crude oil is sourced (EIA-4, 2017), (EIA-5, 2017). We assume that most of this crude is from Alberta, as AER and CAPP show Alberta to be the major source of crude oil from Canada.

Figure 3.14: Canadian and US Pipelines (CAPP)



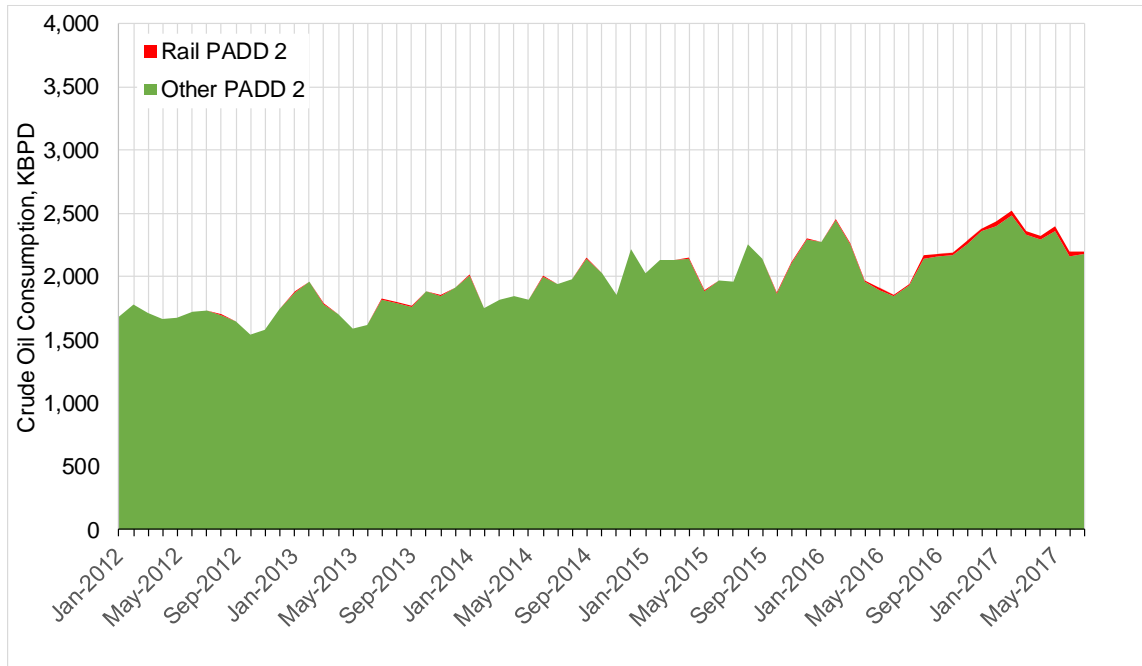
(CAPP-2, 2017)

Figure 3.15: Transport of Canadian Crude Oil to the US



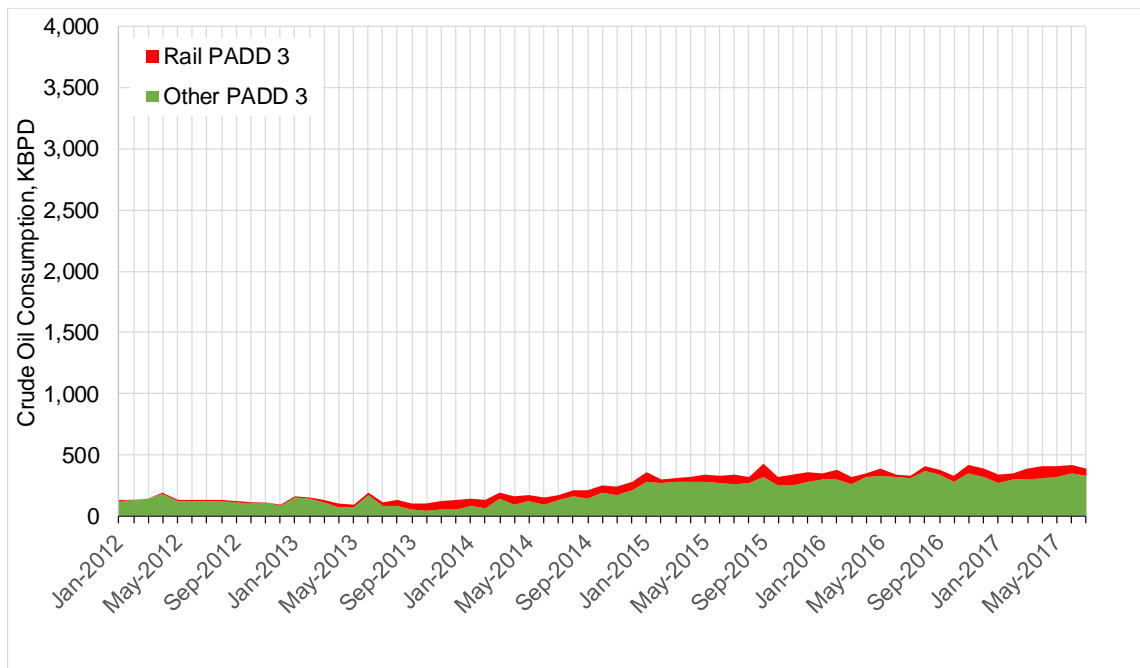
(EIA-4, 2017) (EIA-5, 2017) Analyzed and plotted by Jacobs

Figure 3.16: Transport of Canadian Crude Oil to PADD 2



(EIA-4, 2017) (EIA-5, 2017); analyzed and plotted by Jacobs

Figure 3.17: Transport of Canadian Crude Oil to PADD 3



(EIA-4, 2017) (EIA-5, 2017); analyzed and plotted by Jacobs

With plans to increase heavy crude oil production in Alberta by 1.3 MM BPD by 2030, where will these additional barrels go? Is future demand for US refined products sufficient? is the US crude market big enough for this additional Alberta crude oil?

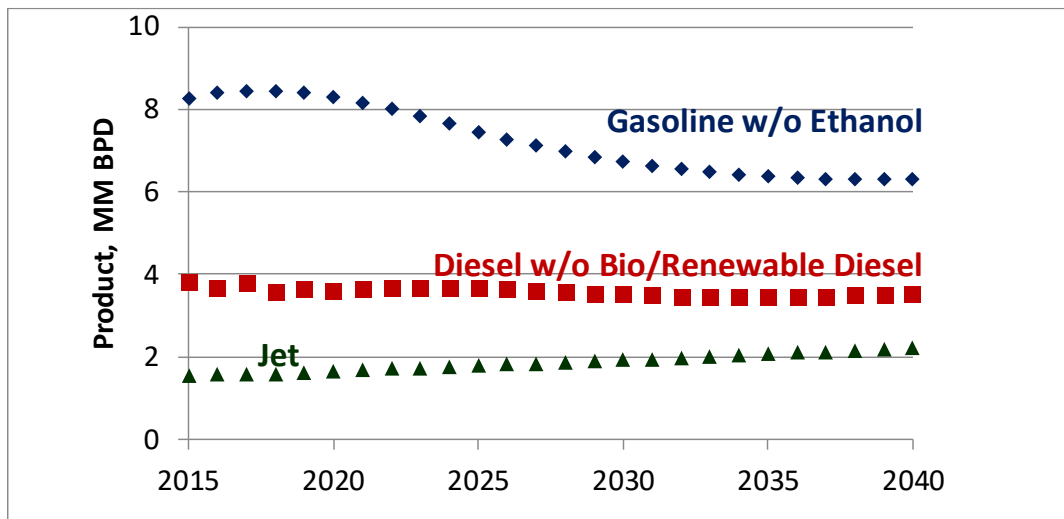
As discussed above, US refining capability has not changed much over the last seven years. According to the EIA, operating crude oil distillation capacity has grown less than 1%/year over this period. Further, US refined product demand is expected to remain relatively flat in the future.

Projections by the EIA of the hydrocarbon portion of gasoline, jet fuel, and diesel fuel demand in their Annual Energy Outlook show gasoline demand declining by 1.2% per year, jet fuel demand increasing by 1.4% per year, and diesel fuel demand decreasing by 0.2% per year (Figure 3.18) (EIA-6, 2017).

Much of the decline in US fuel demand is a result of higher corporate average fuel economy (CAFE) standards for light duty vehicles and higher efficiency standards for heavy duty vehicles (EIA-6, 2017), (NHTSA, 2017), (EPA, 2016). Reduced hydrocarbon based fuel use also results from increased use of renewable and alternative fuels (EPA RFS, 2018).

Future opportunity to process more heavy crude oil from Alberta will result from displacing crude oil from other suppliers.

Figure 3.18: US Demand Forecast for Light Transportation Fuels: Hydrocarbon Only



(EIA-6, 2017); Plotted by Jacobs

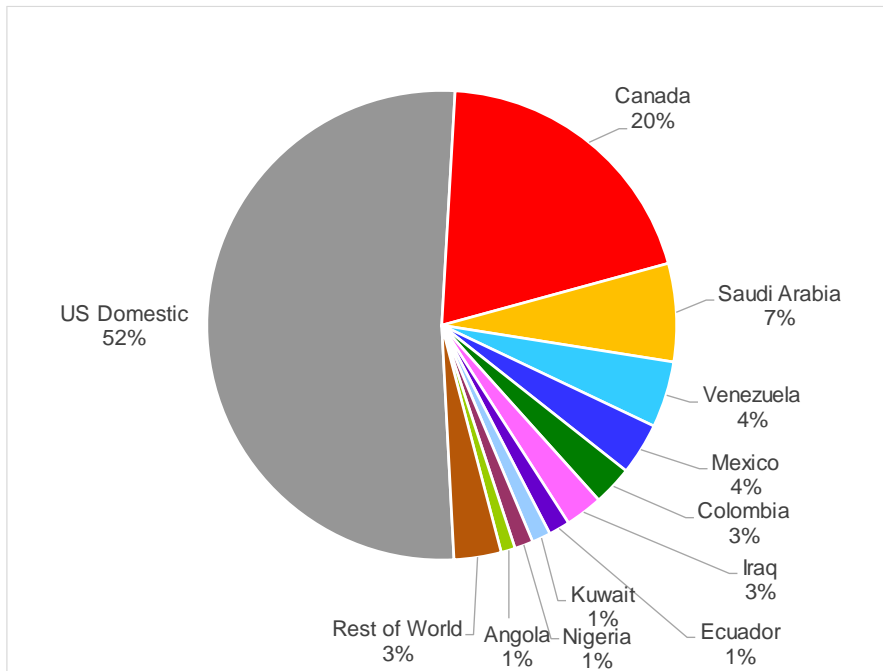
Let us next look in more detail at the US market for crude oils by quantity refined, by country of origin and by API gravity.

### 3.6 US Markets for Canadian Crude Oil

In 2016, the US refined 16.3 MM BPD of crude oil (EIA-11) . Of this, 7.9 MM BPD were supplied by imports and 8.4 MM BPD were supplied by domestic production. Let us next look at the countries supplying crude oil and where these crude oils are refined in the US.

According to the US EIA (EIA-4, 2017), Canada supplied 3.3 MM BPD of crude oil in 2016, 41% of crude oil imported to the US in that year. In 2016, Saudi Arabia supplied 1.1 MM BPD, Venezuela supplied 0.7 MM BPD, and Mexico supplied 0.6 MM BPD of crude oil to the US. Figure 3.19 shows the top ten suppliers of imported crude oils to the US and the percent of 2016 crude oil demand supplied by domestic production.

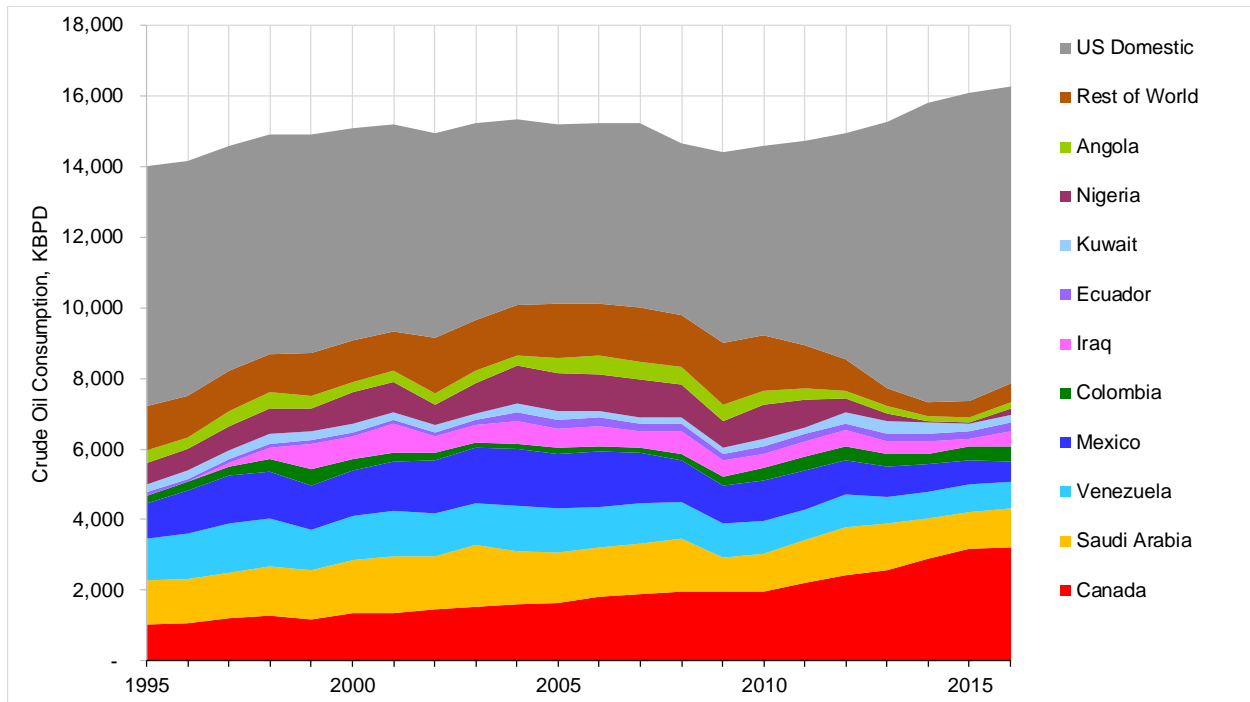
Figure 3.19: Supply of Crude Oil to US Refineries in 2016



(EIA-4, 2017); Analyzed and plotted by Jacobs

Figure 3.20 shows the historical supply of crude oil to the US from the top ten suppliers, the rest of the world, and US domestic production (EIA-4, 2017). The countries tracked in this figure were the top ten suppliers of crude oil to the US in 2016. Overall demand for crude oil in the US has grown by 0.7% per year from 2006 to 2016. US domestic supply of crude oil has grown by 5.1% per year over this period. Canadian crude oil supply to the US has grown by 6% per year since 2006.

Figure 3.20: Historical Supply of Crude Oil to US Refineries



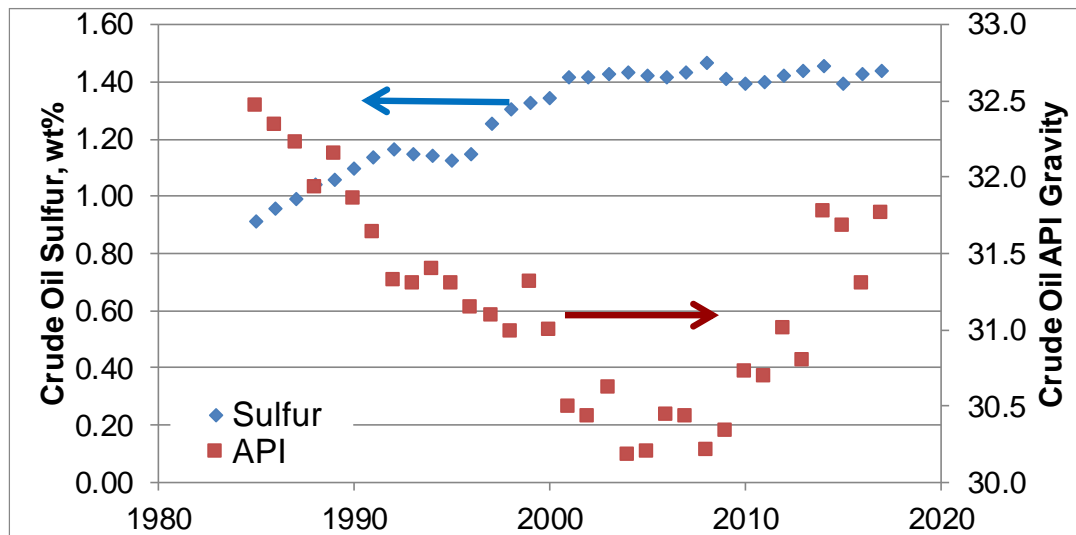
(EIA-4, 2017); Analyzed and plotted by Jacobs:

Most of the growth in US domestic crude oil supply has been light sweet crude oil from tight oil formations (EIA-12, 2017). Figure 3.21 shows trends in API gravity and sulfur for the average crude oil refined in the US since 1980. From 1980 to around 2005, the average crude oil became heavier (lower API gravity) and higher in sulfur. However, since 2005, as a result of increased production of light tight oil, the average crude oil API gravity increased. Sulfur has not changed much since 2005.

Figure 3.21 shows the trend in API gravity for the average mix of imported crude oil to the US since 2001, based on crude oil import data from the EIA. This figure also shows the average mix of crude oil refined in the US for this time period, which is also from the EIA. The average mix of domestic crude oil supplied to US refineries shown in Figure 3.22 is calculated from imported and total crude oil supply data from the EIA.

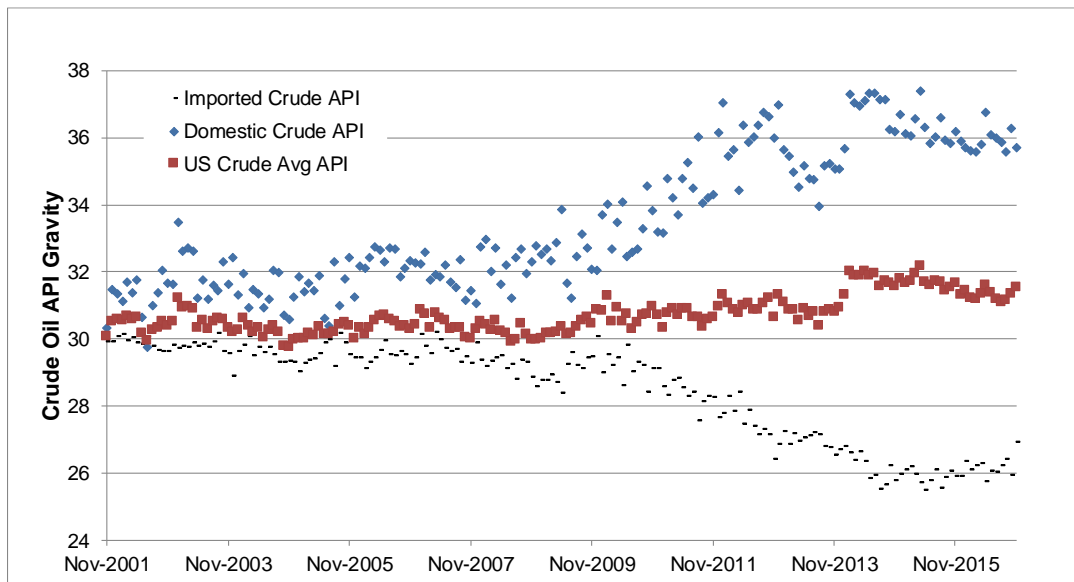


Figure 3.21: Change in API Gravity and Sulfur of Crude Oil Refined in US



(EIA-7, 2017); Plotted by Jacobs

Figure 3.22: Change in API Gravity of US Crude Oil Supply Since 2001



(EIA-7, 2017) (EIA-8, 2017); Domestic crude API estimated by Jacobs

These results show that the mix of US domestic crude oils is getting lighter and the mix of imported crude oils is getting heavier. However, the overall mix of crude oils refined in the US is getting only slightly lighter. This is consistent with how crude oils are chosen and processed: refiners choose crude oils based on price and the ability of their refinery to meet market demand for refined products while maximizing their profits. Although crude oils can be substitutes for each other,

refiners will keep the overall properties of the crude oil mix they process in a fairly narrow range to match the refinery’s processing capability. It is expensive to make major processing changes in a refinery to accommodate a crude oil that changes the refinery’s preferred crude oil mix.

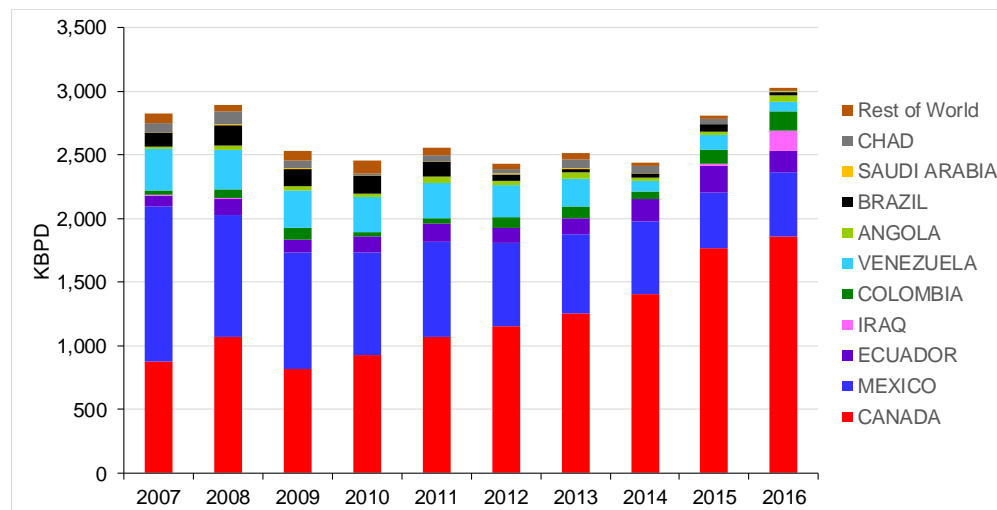
US refining capability has not changed much since 2010. As discussed above, and shown in Figures 3.10 and 3.11, the US has not undergone significant change in major refinery distillation capacity or coking (bottoms conversion) capacity since 2010, which means that the overall crude processed has not changed much.

The next discussion will look at crude imports into the US to identify opportunities for the additional heavy bitumen based crude oil from Alberta, either as dilbit or partially upgraded bitumen.

### 3.6.1 20-25 API Gravity Crude Oil Imported into the US

Let us focus on crude oils in the range 20-25 API range, to better understand US markets for partially upgraded bitumen from Alberta. Pipelines from Canada require Canadian heavy crude oil to be greater than 19 API gravity and less than 350 cSt. To meet this viscosity specification, most heavy Canadian crude oil is a minimum of 20 API gravity and we focus on this range. Figure 3.23 shows US import of crude oils with API gravity in 20-25 API gravity range. Canada is the largest and growing supplier of crude oils in this range. Other countries, notably Mexico and Venezuela show declining supply of crude oil in this API range. There is more discussion on the US crude markets in Appendix D.

Figure 3.23: US Crude Import 20-25 API Gravity

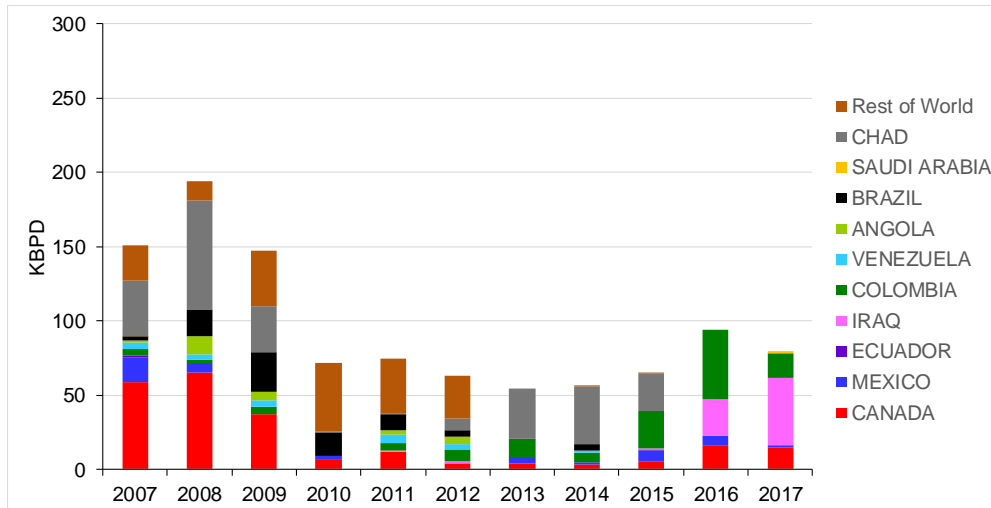


(EIA-9, 2017); Analyzed and plotted by Jacobs

### 3.6.2 20-25 API Gravity Crude Oil Imported into PADD1

The number of operating refineries has decreased in PADD 1 since 2010 as has crude distillation capacity (Appendix D). This PADD has little coking capacity. Figure 3.24 shows crude oil imports to PADD 1 between 20-25 API. There has been a decline in the amount of crude oil supplied to PADD 1 in this range from its peak in 2008.

Figure 3.24: Crude Oils Imported to PADD 1 20-25 API Gravity



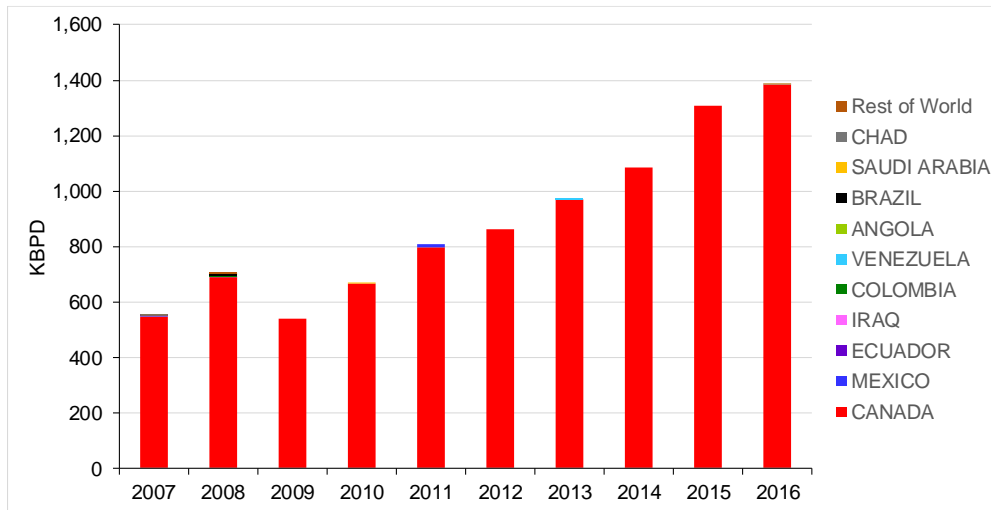
(EIA-9, 2017) Analyzed and plotted by Jacobs

PADD 1 has historically not been a market for Alberta heavy crude oils. It is logistically distant from Alberta and lacks bottoms conversion capacity. Most crude oils imported from Canada to PADD 1 are in the range of 30-35 API (Appendix D) and are from Canada's east coast.

### 3.6.3 Crude Oil Imported into PADD2

PADD 2 has seen no increase in crude atmospheric distillation capacity. But has seen small increases in vacuum distillation and coking capacities (Appendix D). PADD 2 has seen big changes in the import of crude oil in the 20-25 API range. Nearly all of this oil came from Canada (Figure 3.25).

Figure 3.25: Crude Oils Imported to PADD 2 between 20-25 API Gravity



(EIA-9, 2017); Analyzed and plotted by Jacobs

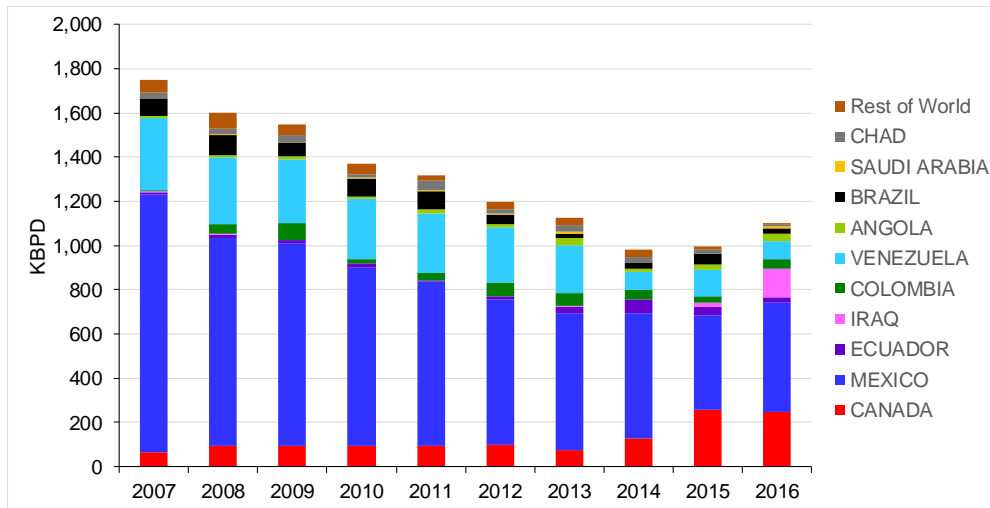
Most of the growth in imports of crude oil from Canada to PADD 2 have been in the 20-25 API gravity range (Appendix D). The growth in capacity for Canadian heavy crude oil in the 20-25 API range seems to be slowing. Further capacity for this type of crude must be found elsewhere.

### 3.6.4 20-25 API Gravity Crude Oil Imported into PADD3

PADD 3 has seen a small increase in crude atmospheric distillation capacity and a small increase in vacuum distillation capacity and coking capacity (Appendix D).

PADD 3 has seen a decline in imports of crude oil in the 20-25 API range. Most of this crude oil came from Mexico. There has been an increase in imports in this API range from Canada, especially since 2014 (Figure 3.26).

Figure 3.26: Crude Oils Imported to PADD 3 between 20-25 API Gravity



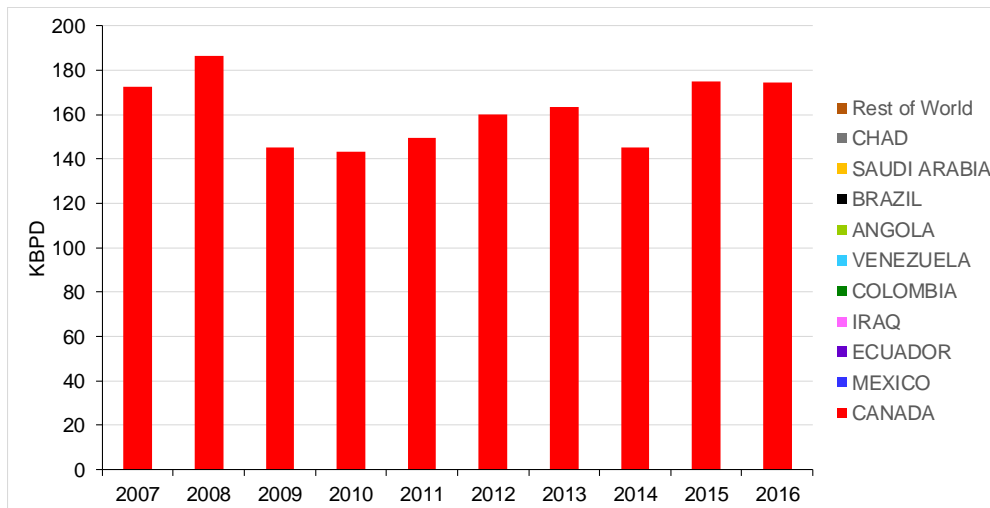
(EIA-9, 2017); Analyzed and plotted by Jacobs

### 3.6.5 20-25 API Gravity Crude Oil Imported into PADD4

PADD 4 has seen a small increase in crude atmospheric distillation capacity, a small increase in vacuum distillation capacity, and no increase in coking capacity (Appendix D).

PADD 4 has seen little or no change in imports of crude oil in the 20-25 API range. All of this oil came from Canada (Figure 3.27).

Figure 3.27: Crude Oils Imported to PADD 4 between 20-25 API Gravity

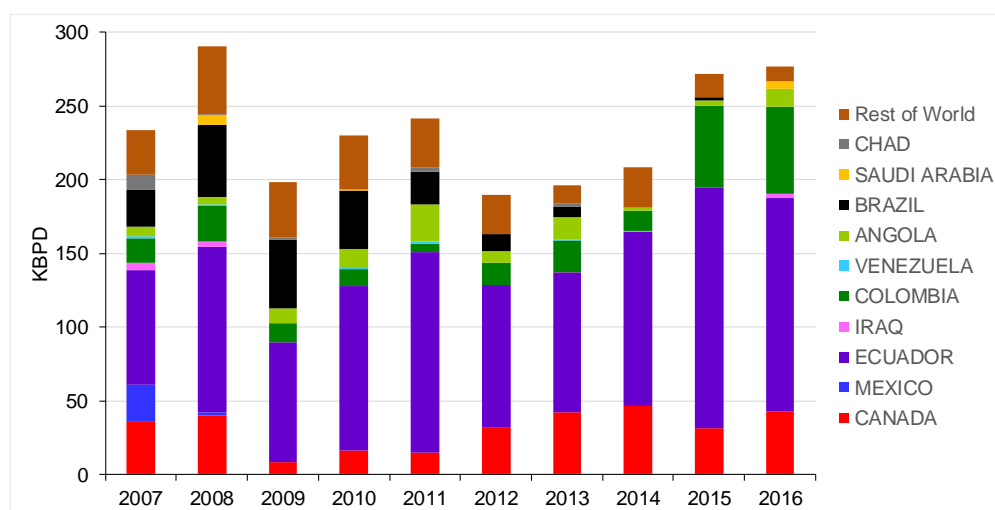


(EIA-9, 2017); Analyzed and plotted by Jacobs

### 3.6.6 20-25 API Gravity Crude Oil Imported into PADD 5

PADD 5 has seen a decline in the number of operating refineries since 2010 but very little change in overall processing capabilities. Crude atmospheric distillation capacity has decreased slightly as has vacuum distillation capacity and coking capacity (Appendix D). PADD 5 has seen little or no change in imports of crude oil in the 20-25 API range. This crude oil comes from a number of countries; very little comes from Canada (Figure 3.28). California has its own supply of heavy crude oil from the San Joaquin valley.

Figure 3.28: Crude Oils Imported to PADD 5 between 20-25 API Gravity



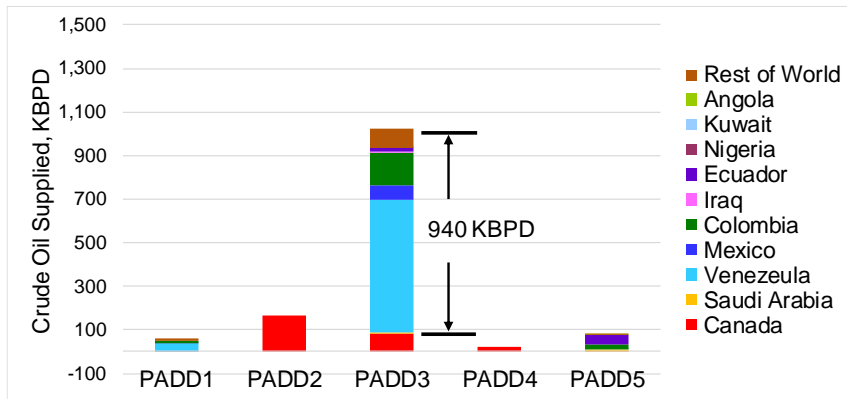
(EIA-9, 2017); Analyzed and plotted by Jacobs

### 3.7 Market Opportunities for Alberta Heavy Crude Oils in the US

CAPP and AER both project that by 2030, bitumen production in Alberta will increase by around 1.3 MM BPD. This bitumen, if shipped via pipeline as dilbit, will be in the 20-25 API gravity range.

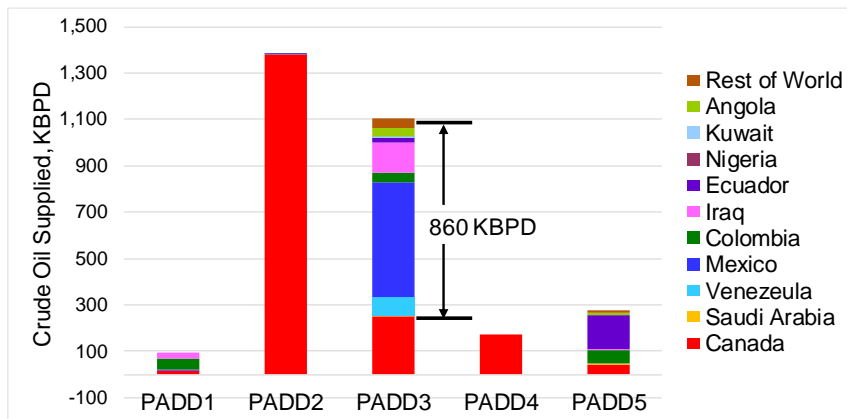
Access to the US market for this additional Alberta heavy crude oil requires displacing crude oil supplied by other countries. PADD 1 has little or no access to heavy oil from Alberta and no capacity to refine this crude. PADD 5 has the conversion capacity to process heavy crude oils, but access to heavy crude oil from Alberta is limited. Further, California is well supplied by its own heavy crude oil, and refiners will incur costs if greenhouse gas emissions from refining heavy crude oils increase. PADDs 2 and 4 are fully supplied with crude oil from Alberta. Only PADD 3 has potential room for Alberta heavy crude oil. Figures 3.29-3.32 show the import of crude oils into US PADDs by API gravity in 2016 and the potential crude that could be displaced in PADD 3 by Canadian crude oil.

Figure 3.29: 2016 Imports of < 20 API Crude Oil



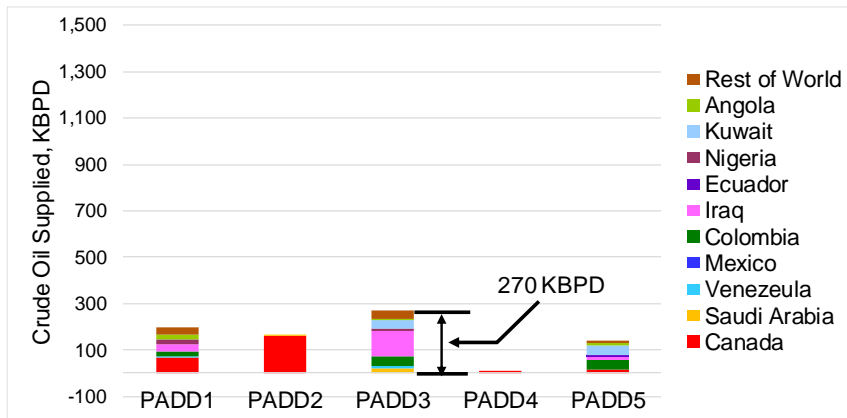
(EIA-9, 2017); Analyzed and plotted by Jacobs

Figure 3.30: 2016 Imports of 20-25 API Crude Oil



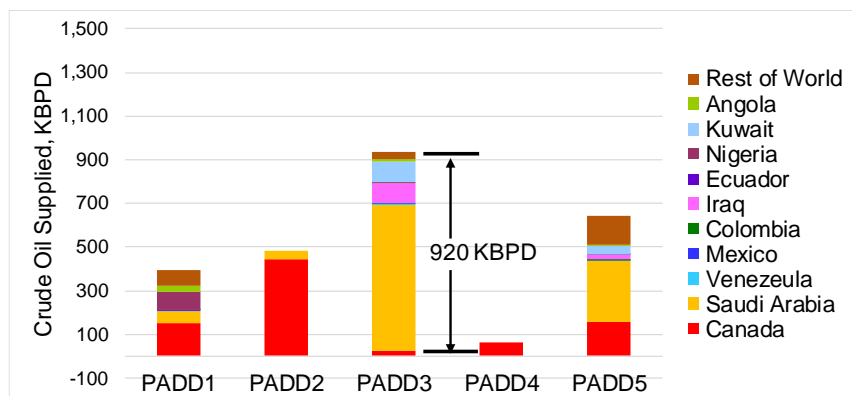
(EIA-9, 2017); Analyzed and plotted by Jacobs

Figure 3.31: 2016 Imports of 25-30 API Crude Oil



(EIA-9, 2017); Analyzed and plotted by Jacobs

Figure 3.32: 2016 Imports of 30-40 API Crude Oil



(EIA-9, 2017); Analyzed and plotted by Jacobs

The quantity of crude oil that could potentially be displaced in PADDs 3 and 5 by Canadian crude oil is shown in Table 3.3. These results are based on 2016 import volumes. The analysis here shows potential markets. Whether the markets are available to this oil depends on many factors. Determining markets for crude oils depends on price and refining capability. Refiners routinely use linear programming with sophisticated models to make decisions on which crude to process to maximize their economic return. It also depends on the response of crude oils suppliers who will be displaced by Canadian crude oil.

Table 3.3: Potential Crude Oil Displacement by Alberta Crude Oils

		Crude Oil API Range			
		< 20	20-25	25-30	30-40
PADD3	KBPD	940	860	270	920
PADD5	KPBD	80	230	130	490

Most crude < 25 API is from Venezuela and Mexico and could be replaced by dilbit or partially upgraded bitumen. Crude oil 25-40 API is primarily from Ecuador, Colombia, Iraq, and Saudi Arabia and could be replaced by SCO from a full upgrading operation. However, adding new full bitumen upgrading capacity in Alberta is expensive and not planned at this time. Also, consider that dilbit is around a 30/70 mixture of condensate (API gravity ~65) and bitumen (API gravity ~ 8-12). The US is awash in condensate as a result of fracking to produce natural gas and light tight crude oil. Diluent removed from imported dilbit will compete with this US domestic condensate. Demand for non-Canadian crude oil < 20 API in PADD 3 was 940 KBPD in 2016. Demand for this range of crude in PADD 5 was 80 KBPD. For these markets to be open to Canadian crude oil, either the pipeline specifications must be relaxed or it must be transported by rail.



The US market for refined products is projected to shrink by 2030 according to the EIA, and discussed above. US refineries, especially in PADDs 3 and 5 have ready access to crude oils that can be delivered via blue water transport (large tanker ships). PADDs 3 and 5 will be challenged to absorb the 1.3 MM BPD of additional bitumen projected to be supplied by Alberta by 2030. PADDs 2 and 4 are fully supplied by Canada and there are no imports of heavy crude oil from other countries to these PADDs. Without significant, expensive refinery investment, there is not much room for additional heavy Alberta crude oil in PADDs 2 and 4. If the additional heavy crude oil from Alberta cannot be placed in PADDs 3 or 5, it will have to find other markets or be upgraded to better fit the existing US refinery configurations.

### **3.8 Market Opportunities for Alberta Heavy Crude Oils in Asia**

Potential markets for Alberta crude oil are in the EU, Latin America, and Asia. EU refining markets are not growing. Latin America competes with Alberta for crude markets and its refining capacity is not growing much. New markets for Alberta crude oils are likely to be in Asia.

Table 3.4 compares refining capacity for major bottoms conversion in China, India, Japan, and Korea with capacity in PADD 3. Crude oil distillation capacity is shown in KBPD. Major bottoms processing capacity: vacuum unit, coking unit, thermal cracking, and residue hydrotreating and hydrocracking are shown as percent of crude capacity. Distance from Alberta to markets is shown via Houston, using existing pipeline infrastructure, or via Burnaby (or another port in British Columbia), using what will most likely be new pipeline capacity.

Some observations of the Asian markets are as follows:

- China is expected to add refining capacity to meet demand for products. Security of crude oil supply is a major issue for China. China has great demand for light naphtha in condensate for petrochemical production which could actually make dilbit more appealing than it is otherwise in North America.
- Japan has the most vacuum unit capacity relative to crude unit capacity of the Asian countries that could be targeted for Alberta crude oil. However, the Japanese refining industry has been shrinking for a number of years.
- Japan has residue hydrotreating capacity to make sweet (low sulfur) fuel oil. This capacity does not provide much conversion of residue. Japan could be a target for partially upgraded bitumen that incorporates asphaltene rejection to reduce MCR.
- South Korea has little or no coking capacity but has residue FCC units that can handle some bottoms material and regularly processes heavy oil, up to the capability of these units. South Korea could be a target for partially upgraded bitumen produced with asphaltene rejection to reduce MCR. Petroleum refining in South Korea is modern and designed to supply refined products for export.

- India has more coking capacity than other Asian countries. Since publication of the data used in Table 3.4, India has added more coking capacity. India is an excellent target market for both unconverted and partially converted bitumen. India has great demand for light naphtha in condensate for petrochemical production. India has growing domestic demand but also growing capability to supply products for export. However, India is close to the oil markets in the Middle East.
- Distances to Asian markets are around 14,000 miles via Houston, which includes 2,700 miles of pipeline from Alberta to Houston.
- Distances to Asian markets via Vancouver are around 6,000 miles to China, Japan, and South Korea, but around 12,000 miles to Mumbai. These distances include the 720-mile pipeline from Alberta to Burnaby B.C.
- None of the Asian countries are as well positioned to process Alberta heavy crude oil as PADD 3
- Refining systems with residue hydrogen addition capacity can process partially upgraded bitumen. Table 3.4 shows the residue hydrogen addition capacity in each region. If we assume that 50% of the material in PUB must be treated via residue hydrogen addition, these data suggest that the regions shown in Table 3.4 could process twice the capacity shown for existing residue hydrogen addition, or around 5 MM BPD of PUB.

**Table 3.4: Asian Refining Capacity and Distance from Alberta Production**

		China	India	Japan	Korea	US PADD 3
Crude Capacity	KBPD	7,066	4,343	4,423	2,959	9,211
<b>Process Capacity to Crude Capacity</b>						
Vacuum Unit	% of Crude Cap.	3.4	18.7	36.6	17.4	45.2
<b>Coking</b>						
Fluid	% of Crude Cap.	-	3.1	1.2	-	0.7
Delayed	% of Crude Cap.	2.2	0.8	1.6	0.6	15.2
Total Coking	% of Crude Cap.	2.2	3.9	2.8	0.6	15.9
<b>Thermal Cracking</b>						
Visbreaking	% of Crude Cap.	-	1.7	0.5	-	0.1
<b>Residue Hydrogen Addition</b>						
Residue Hydrocracking	% of Crude Cap.	-	-	1.1	8.2	1.6
Residue Hydrotreating	% of Crude Cap.	1.9	-	10.3	4.9	2.0
Residue Hydrotreating/ Hydrocracking	% of Crude Cap.	1.9	-	11.4	13.1	3.6
Residue Hydrogen Addition capacity	KBPD	268		1008	775	663
<b>Distance</b>						
<b>Alberta to Asia via Houston</b>						
Bluewater	Miles	11,500	11,500	11,000	11,000	-
Pipeline Alberta to Houston	Miles	2,700	2,700	2,700	2,700	2,700
Total	Miles	14,200	14,200	13,700	13,700	2,700
<b>Alberta to Asia via Vancouver</b>						
Bluewater	Miles	5,900	10,900	5,300	5,300	-
Pipeline Alberta to Vancouver	Miles	720	720	720	720	-
Total	Miles	6,620	11,620	6,020	6,020	-

Sources: Refining capacity: (Pennwell, 2014); Sea Distances: (Sea-Distances.org, 2017); Pipeline distances (Kinder Morgan, 2017)and (TransCanada, 2017)

### 3.9 Pricing Heavy Crude Oil

Crude oil prices quoted by analysts generally refer to a small group of specific crude oils (benchmark crude oils) that are widely and actively traded. Use of benchmark crudes makes it easier for buyers and sellers to price the various crude oils produced around the world.

Benchmark crude oils typically have five characteristics in common:

1. Stable and ample production
2. Transparent, free-flowing market located in a geopolitically and financially stable region to encourage market interaction
3. Adequate storage to encourage market development
4. Delivery points at locations suitable for trade with other markets, enabling arbitrage so that prices reflect global supply and demand
5. Fungible with ready substitutes

Three of the most significant benchmarks in global crude oil markets are Brent, West Texas Intermediate (WTI), and Dubai/Oman. Heavy crude oils from Alberta use Western Canadian Select (WCS) as a benchmark.

**Brent**, is the most widely used global crude oil benchmark. It includes four separate light, sweet crude oil streams produced in the North Sea: Brent and Forties (produced offshore UK) as well as Ekofisk and Oseberg (produced offshore Norway). Brent is used to price light, sweet crude oil that is produced and traded in not only Europe, the Mediterranean, and Africa but also Australia and some countries in Asia. It is estimated that 60% of the world's traded oil is priced off of Brent.

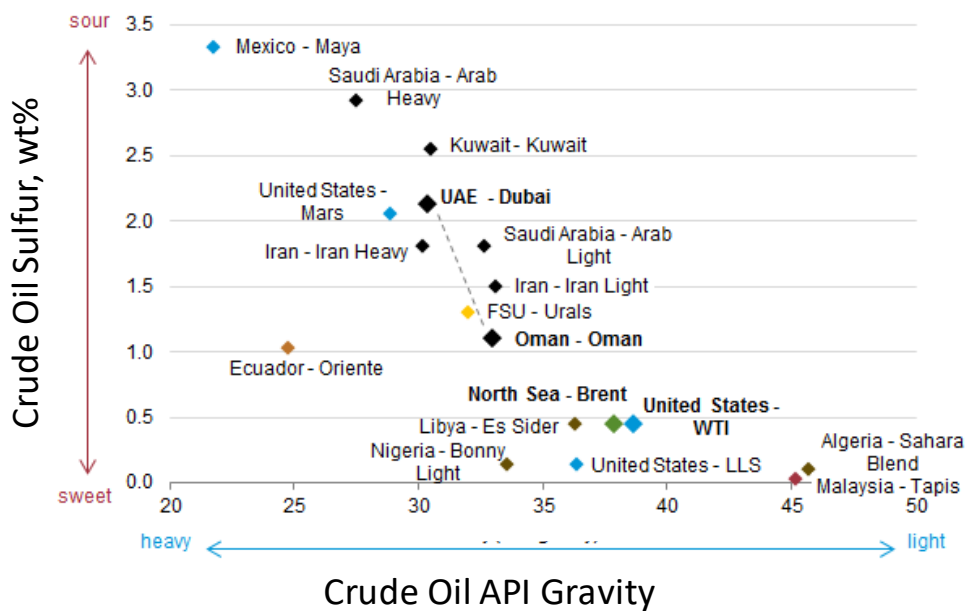
**West Texas Intermediate (WTI)** is a light, sweet crude oil produced in the United States that is priced at the crude oil trading hub of Cushing, Oklahoma. WTI is used as a benchmark for other types of crude oil produced in the United States, such as Mars, a medium, sour crude produced in the Gulf of Mexico, and Bakken, a light, sweet crude produced in North Dakota. WTI is also used as a benchmark for imported crude oil produced in Canada, Mexico, and South America. A major drawback to WTI is that access to the US Gulf Coast and world markets via pipelines is logistically more complex than for waterborne crude oils like Brent.

**Dubai/Oman** is a third major benchmark crude. The prices of Dubai and Oman crudes, both of which are medium and sour, are often averaged to create a benchmark that is typically used to price crude oil produced in the Middle East and exported to Asian markets. Dubai crude oil production has steadily declined for more than two decades, and in 2013 was only 34,000 BPD. As a result, Oman crude oil, which reached 0.94 MM BPD of production in 2013, has been used to support the continued use of Dubai crude as a benchmark. Saudi Aramco uses the Dubai/Oman benchmark when determining the price of its crude oil sold for delivery to Asia.

**Western Canadian Select (WCS)** is a heavy crude oil composed mostly of bitumen blended with condensate diluents as well as SCO and conventional Alberta crude oils at the large Husky terminal in Hardisty, Alberta. WCS is one of North America's largest heavy crude oil streams and is the benchmark for emerging heavy crude oils delivered to the US Gulf Coast.

Other crude oils can be compared with these benchmarks by agreed-upon differentials, which take into account factors such as API gravity, sulfur content, sometimes TAN, transportation costs from production areas to refineries, regional and global supply and demand conditions, including refinery utilization. Figure 3.33 shows API gravity and sulfur for a number of crude oils.

**Figure 3.33: Sulfur and API Gravity of Crude Oils**



(EIA-10, 2013)

The price for partially upgraded crude oils would be related to the price of WCS depending on the changes in partially upgraded crude oil quality. In a 2015 study, Muse Stancil Inc. (Muse Stancil, 2015) identified the following parameters that affect the value to refineries of partially upgraded crude, relative to diluted bitumen:

- Sulfur content of the crude oil
- Coke-forming tendency of the crude oil, measured as the microcarbon-residue (MCR) content (see further discussion in Chapter 4).
- Distillate fraction in the crude oil
- Quality of the heavy distillates (vacuum gas oil fraction aromaticity factor)

There was no direct correlation for value with C<sub>5</sub> asphaltene content. This result does not mean that the asphaltenes are a desirable component in crude oils, but rather that the parameter of MCR content captured the impact of the concentration of C<sub>5</sub> asphaltenes because the two parameters are cross-correlated.

Crude oil prices received by the producer are net of transportation costs to market. Similar heavy crude oils from Mexico and Alberta selling for similar prices in Houston will net the producers different amounts of money. It costs nearly US\$10/bbl to ship oil from Fort McMurray to Houston via pipeline but typically only around a dollar per barrel by ship from the east coast of Mexico.

As discussed above, in the second quarter of 2017, the cost of using diluent to transport bitumen was around \$US14/bbl of bitumen. Eliminating diluent use is the biggest incentive to partial upgrading. Access to open markets and low cost transportation are key to profitability.

### 3.10 Other Market Forces Affecting Heavy Crude Oil

The price of heavy crude oils may be affected by restrictions on bunker fuel sulfur under MARPOL Annex VI and by the availability of low cost LNG on the world market (Jacobs Consultancy, 2017). Figure 3.34 shows the average price from 2015-2017 for landed LNG in different markets (FERC, 2018).

Figure 3.34: Worldwide Landed LNG Price: Average 2015-2017 – Prices are US\$/MM BTU



(FERC, 2018)

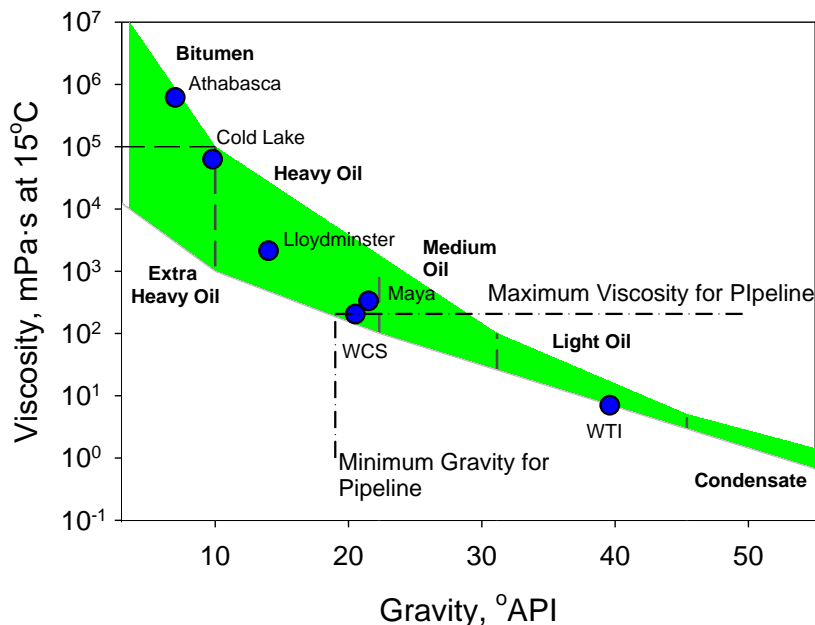
Although ships may use scrubbers to meet emissions standards of MARPOL VI, which go into effect January 1, 2020, it is uncertain how many will. The availability of low cost LNG on the world market may affect demand for heavy fuel oil for marine fuel and stationary use. It is likely that any heavy fuel oil displaced from marine and stationary use will go into refineries with bottoms conversion, which could reduce demand for heavy crude oils and increase the light-heavy crude oil differential.

## 4. Bitumen and Heavy Oil Fundamentals<sup>1</sup>

### 4.1 Bitumen Composition

Bitumen and heavy oil are naturally-occurring petroleum materials that are characterized by high density and high viscosity. Bitumen has a density of 1,000 kg/m<sup>3</sup> or higher, which corresponds to a gravity of 10 °API or less. Heavy oil is commonly defined as petroleum material with density between 922 and 1,000 kg/m<sup>3</sup>, with a viscosity too high for pipeline transportation at ambient temperature. A comparison of a variety of crude oils is shown in Figure 4.1 together with the typical limit for pipeline transportation.

Figure 4.1: Crude Oil Viscosity and Density Comparison



(Gray, 2015)

These materials are part of a continuum of petroleum or crude oil materials. All of the main components of bitumen and heavy oil are also present in lighter, more valuable crude oils but at lower concentrations. For convenience, the term “bitumen” will be used throughout this section to indicate heavy petroleum material, but in every case the same comments will apply to heavy oils.

Petroleum is an extremely complex mixture of hundreds of thousands or millions of chemical components containing the elements carbon, hydrogen, sulfur, oxygen, nitrogen, vanadium, and nickel (Gray, 2015) An increase in density is correlated with an increase in carbon, sulfur, and

<sup>1</sup>Section 4 - Bitumen and Heavy Oil Fundamentals - is by Murray R. Gray



nitrogen (Gray, 2002), and with an increase in the size of molecules. Bitumens are richer in these elements and in larger molecules than lighter crude oils. In addition to elemental analysis and density, petroleum materials are characterized by their boiling fractions, by solubility, and by specific assays for chemical functional groups or reaction properties. Typical data for Athabasca bitumen are listed in Table 4.1. Other bitumens and heavy oils from Western Canada have similar properties. Rather than listing all of the terminology for petroleum composition and properties here, a glossary is attached at the end of this report in Appendix A.

**Table 4-1. Composition and properties of Athabasca bitumen**

Component	Units	Value
Carbon	wt%	83.1
Hydrogen	wt%	10.6
Sulfur	wt%	4.8
Nitrogen	wt%	0.4
Vanadium	wt ppm	145
Nickel, ppm by weight	wt ppm	75
Density	kg.m <sup>3</sup>	1015
Gravity	°API	7.9
Viscosity at 25°C	cP or mPa·s	300,000
Boiling fractions		
Light gas oil (LGO, 177-343 °C)	wt%	10
Heavy gas oil (HGO, 343-524 °C)	wt%	40
Vacuum residue, 524°C +	wt%	50
Micro carbon residue (MCR)	wt%	13.6
Asphaltene, heptane (C <sub>7</sub> ) insoluble	wt%	11.5
Asphaltene, pentane (C <sub>5</sub> ) insoluble	wt%	17.2

(Gray, 2015)

Laboratory assays determine the boiling fractions in petroleum and indicate how much material will vaporize at a given temperature. This information provides insight on how much material is available to process into different refinery products. Due to the abundance of sulfur and nitrogen in bitumen, the low concentration of hydrogen, and the large size molecules in bitumen, approximately half of the bitumen will not distill even at a maximum temperature of 350°C under vacuum. This material is called vacuum residue, which has normal boiling points at atmospheric pressure ranging from 524°C to over 720°C. When this fraction is subjected to temperatures over 350°C, it reacts to form smaller molecules and solid insoluble material called “coke.” The tendency of bitumen to form coke is measured under standardized reaction conditions as either the Conradson Carbon Residue (CCR) or the Micro-Carbon Residue (MCR), reported as weight percent of sample. These two methods give equivalent results (ASTM, 2017). The weight percent

MCR indicates the amount of difficult to process, carbon rich material in a crude oil or bitumen and is an important indicator for refinery processing.

The solubility of crude oil components is also important for production and upgrading, and standard assays are used to test solubility behavior. When bitumen is diluted in paraffinic solvents, the densest fraction becomes insoluble and precipitates as a solid. This fraction is called asphaltene, and contributes to the weight of the vacuum residue fraction. The asphaltene content of crude oils is determined using a standard procedure using dilution in either *n*-pentane, to give C<sub>5</sub>-asphaltenes, or *n*-heptane to give C<sub>7</sub>-asphaltenes. Both results are reported as mass of asphaltene precipitate per mass of crude oil or bitumen sample. The fraction of crude oil that does not precipitate is commonly separated into saturates, aromatics, and resins by chromatography. The resin fraction is highest in the vacuum residue, along with the asphaltene fraction.

A significant fraction of the asphaltene material is present as aggregates of molecules with a size in the range of 2-20 nm (Yarranton, et al., 2013)). The aggregation of these components prevents comprehensive molecular analysis by any techniques available currently (McKenna, et al., 2013), (Chacón-Patiño, 2017) and gives rise to complex behavior at interfaces. Changes in the asphaltene aggregates are important in determining the viscosity of bitumen blends and in the formation of coke (Wiehe, 1993)

When crude oils are processed at high temperature, the solubility of the asphaltene components tends to decrease. These changes are normally tested by determining the fraction of the product blend that will not dissolve in toluene. Initially, bitumen is completely soluble in toluene, except for mineral contaminants such as clay. With exposure to high temperatures, coke can begin to form, giving material that is toluene-insoluble. A second type of assay examines the compatibility of the processed crude oil with other streams. Compatibility can be examined using spot-tests on filter paper, microscopic examination after dilution with solvents, or titration measurements (Wiehe, 2000), (Wiehe, 2008).

## 4.2 Physical Properties and Dependence on Composition

The primary goal of partial upgrading is to enhance the transportability of bitumen, which focuses on the crucial properties of viscosity and density. The reduction of viscosity to 350 cSt at pipeline operating temperature is the most important target, because this viscosity most commonly controls the amount of diluent required to make bitumen transportable by pipeline. For example, Access Western Blend (AWB) cycles seasonally from 20.3 API° in summer to 23.3 API° in winter, with a long-term average of 21.8 API° (Crude Monitor, 2017). However, for dilbits produced from other bitumen, density may be the limiting specification in summer. As a secondary benefit, partial upgrading may enhance the value of the crude oil by reducing the content of low value or problematic components. In contrast to partial upgrading, full upgrading of bitumen, currently

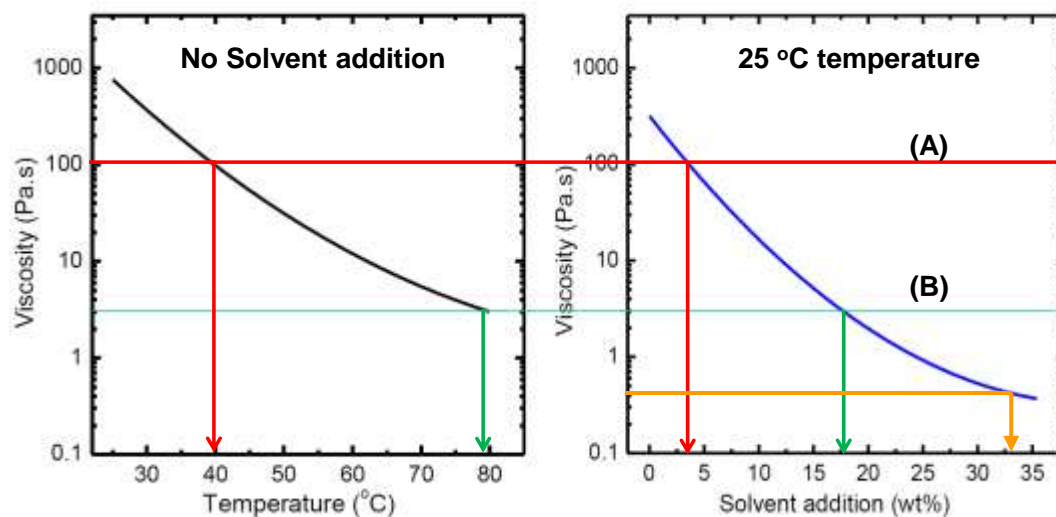
practiced in Alberta and Saskatchewan is focused on improving the value of the crude oil well beyond the minimum transportation specifications.

#### 4.2.1 Reduction in Bitumen Viscosity

The high viscosity of bitumen is due to the high-boiling components in the vacuum residue fraction, which includes the asphaltenes. The strong physical interactions of the large molecules and the aggregated asphaltene species give rise to this high viscosity. Viscosity is extremely sensitive to temperature; an increase in temperature reduces the strength of the molecular interactions and reduces the viscosity. As a blend of these heavy components with lighter material, the viscosity of bitumen is also extremely sensitive to the presence of low-boiling hydrocarbons, i.e. solvents (Seyer, et al., 1989). Both temperature and composition can reduce the viscosity by orders of magnitude, from  $10^6$  mPas to  $10^2$  mPas or less (Seyer, et al., 1989).

An example of the reduction in viscosity due to increase in temperature and solvent addition is shown in Figure 4.2. Biases in measurement of high viscosities are common, due to viscous heating during experiments or the presence of residual solvents (Seyer, et al., 1989), (Bazyleva, et al., 2010)). Errors are much less significant for diluted or upgraded bitumens. In general, any change in viscosity due to composition or temperature, in the absence of chemical reactions, are completely reversible. Once the composition or temperature is returned to the original condition, the viscosity will return to its original value within a few days.

Figure 4.2: Viscosity Reduction via Temperature and/or Solvent Addition



Data are for Athabasca bitumen from (Zhang, 2012)MSc Thesis, U of Alberta, courtesy of JH Masliyeh. The left panel shows viscosity as a function of temperature, and the right panel shows viscosity as a function of addition of naphtha as a solvent. To achieve a viscosity of 100 Pa-s (A), heating to 40°C or addition of 3.5% solvent are equivalent. Reduction to 3Pa-s requires 80°C or 18% solvent. Achieving a pipeline viscosity of approximately 0.3 Pa-s requires around 33% solvent.

In order to achieve a reduction in viscosity, the chemical composition of the bitumen mixture must change due to physical removal or addition of components, or the structure of the components must change due to chemical reaction. The following changes are known to reduce viscosity:

- Increase in the fraction of low-boiling components, by adding a solvent or diluent (physical change), or by cracking large molecules to make small solvent-like fragments (chemical reaction)
- Decrease in the fraction of high boiling components, e.g. vacuum residue and asphaltene, by physical removal or chemical reaction. For the asphaltene fraction, the volume fraction in solution is particularly important (Barre, et al., 2008)
- Reduction in density, due to chemical reactions such as hydrogenation or desulfurization.

Models for viscosity of bitumen and diluted bitumen give directional information on the contributions from the main components as discussed above (Yarranton, et al., 2009) but the complexity of the vacuum residue components and asphaltenes requires experimental data for verification.

#### **4.2.2 Reduction in Bitumen Density**

The target for current pipeline operation is a minimum gravity of approximately 19 °API, or a maximum density of 940 kg/m<sup>3</sup>. The same factors that reduce viscosity also reduce density: more light components, less heavy components, and shifting the elemental composition to increase hydrogen and decrease sulfur and nitrogen content. (Gray, 2002). Reducing the density of bitumen from approximately 1,000 kg/m<sup>3</sup> to approximately 940 kg/m<sup>3</sup> requires the addition of around 24 vol% of 750 kg/m<sup>3</sup> density condensate.

### **4.3 Market Value – Composition Relationships**

Blends containing bitumens are discounted relative to light crude oils because the yields of desirable distillate products are lower and cracking of large components is needed to increase distillate yield. In addition, more processing is required to remove unwanted contaminants such as sulfur and metals and achieve the required product specifications. Additional factors that affect the bitumen price are the acidity of the feed, measured as total acid number (TAN), and the content of olefins, which arise from thermal cracking. High TAN can result in increased corrosion of refining equipment. It does not affect refining yields. Refiners that have not upgraded their refining equipment may not be able to process much high TAN crude oils. Refiners that have upgraded their metallurgy can process more. The data of Table 4-2 list the main components of bitumen that change the crude oil properties of interest to refiners.

**Table 4-2: Effect of Composition Changes on Value of Blends Containing Bitumens**

Bitumen Component	Crude Oil Properties Assessed by Refiners	Effect on Refinery
Vacuum residue, including asphaltenes	Micro Carbon Residue (MCR) content or Conradson Carbon (CCR) C <sub>7</sub> Asphaltene content	Reduced yield of distillate, more coke Limited capacity for processing in some units
Sulfur and nitrogen	Sulfur and nitrogen, weight%	More hydrotreating of products or discounted value
Metals (V and Ni)	Metals, parts per million	Catalyst deactivation
Acids in bitumen	Total acid number (TAN)	Potential for corrosion and corrosion mitigation costs, or limits on feed blends
Olefins	Weight % olefins by <sup>1</sup> H-NMR, Bromine number, diene number	Potential for fouling in refinery equipment, and indicator of unstabilized thermally cracked material
Aromatic compounds in distillates	Vacuum gas oil density, sulfur content, aniline point; Cetane number of distillates	Yields from refinery processing and blending into products

The content of nitrogen compounds is not often examined in crude oil marketing because unlike sulfur, the nitrogen content does not have an environmental impact that is subject to regulation. However, the presence of high nitrogen levels in bitumen has significant impact on catalytic processes used to remove sulfur. Nitrogen has significant negative impact on operation of hydrotreating units in upgraders or refineries. Metals and C<sub>7</sub> asphaltene contents are mainly concerns for catalytic processing of heavy fractions. MCR and Conradson carbon (CCR) are different analytic methods that measure the coke forming tendencies of the oil. Results from the two methods are equivalent. (ASTM, 2017)

#### 4.4 Processing Reactions to Improve Properties and Market Value

Dozens of process technologies have been used over the past century to add value to heavy petroleum fractions by inducing chemical reactions, and many more have been pilot tested. At the base of this process technology is a very limited range of chemistry, consisting of thermal reactions, and a limited set of catalytic reactions. This section reviews the main reactions that are relevant to partial upgrading of bitumen, which emphasises liquid-range products rather than gases. Data are presented from laboratory experiments under idealized conditions. Chapter 5 will describe the process technologies that use these reactions to achieve partial upgrading of bitumen.

## 4.5 Thermal Reactions

Heating of petroleum liquids to over 350°C begins a complex series of reactions at rates that are sufficiently fast to be of commercial and practical interest. The yields and product properties from a given feed depend on the time and temperature history of the components, which in turn affect the formation of vapor phase or solid phase coke. The fundamental reactions are:

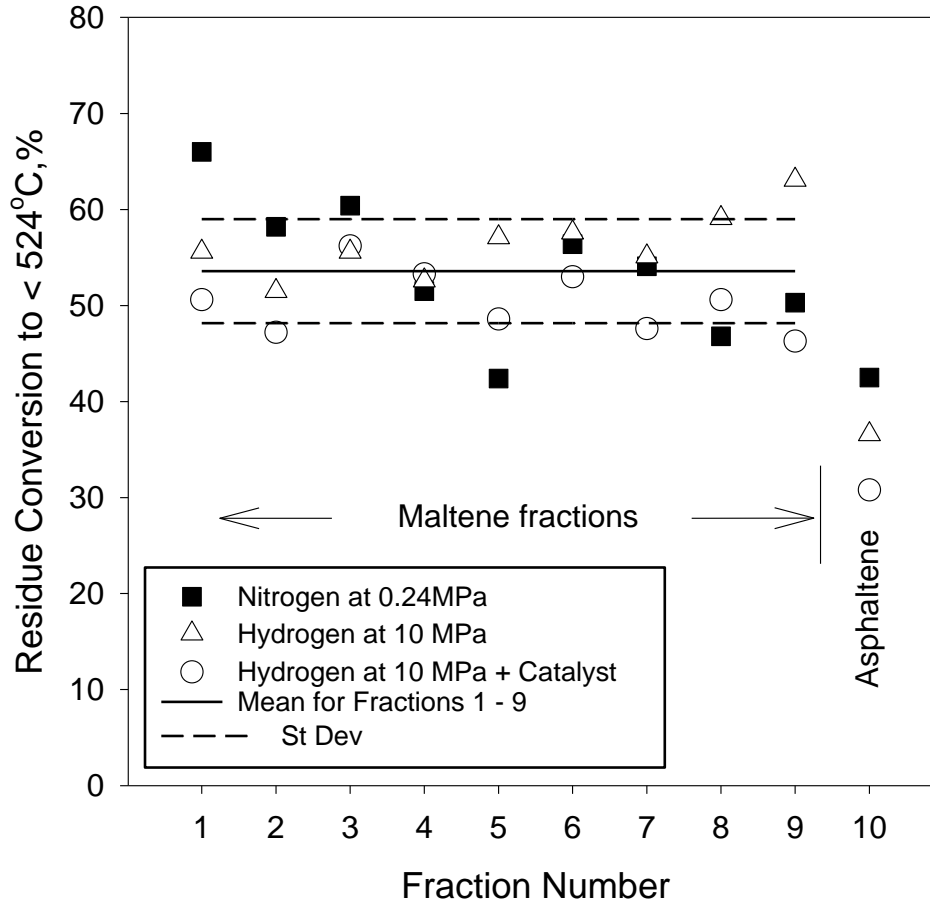
- Cracking, which breaks carbon-carbon, carbon-sulfur, and carbon oxygen bonds to produce liquid and gas products, and reactive species such as olefins and diolefins
- Addition reactions of reactive species in the liquid phase, giving coke precursors
- Hydrogen transfer reactions between hydrogen-rich donor species and hydrogen-deficient acceptors

### 4.5.1 Thermal Cracking

Cracking in the liquid phase gives all three reactions, while cracking in the vapor phase gives mainly cracking, with little addition or hydrogen transfer. Cracking in the vapor phase gives much higher yields of light olefin products, such as ethylene, propylene, and butylenes. Addition reactions in the liquid phase increase the concentration of the asphaltene fraction, which eventually becomes insoluble in the liquid and begins to form solid coke (Wiehe, 1993).

The most reactive components are in the vacuum residue, while the least reactive components are in the middle distillate and naphtha fractions. Within the vacuum residue, the reactivity of the asphaltenes is significantly different. For example, Figure 4.3 shows the conversion of ten fractions of Athabasca vacuum residue by cracking with and without hydrogen. The ten fractions were prepared by extraction with supercritical pentane. The heaviest fraction, number 10, contained most of the asphaltenes (88 wt% C<sub>5</sub> asphaltenes). This fraction resulted in lower conversion to light products than the other fractions but higher coke yield. The asphaltene-rich fraction 10 gave 29% coke yield (as g coke/g fraction 10) when reacted under nitrogen, compared to only 2.7 wt% from fraction 1 and 4.7 wt% from fraction 9.

Figure 4.3: Reactivity of Heavy Fractions of Athabasca Bitumen at 430°C for 1 Hour

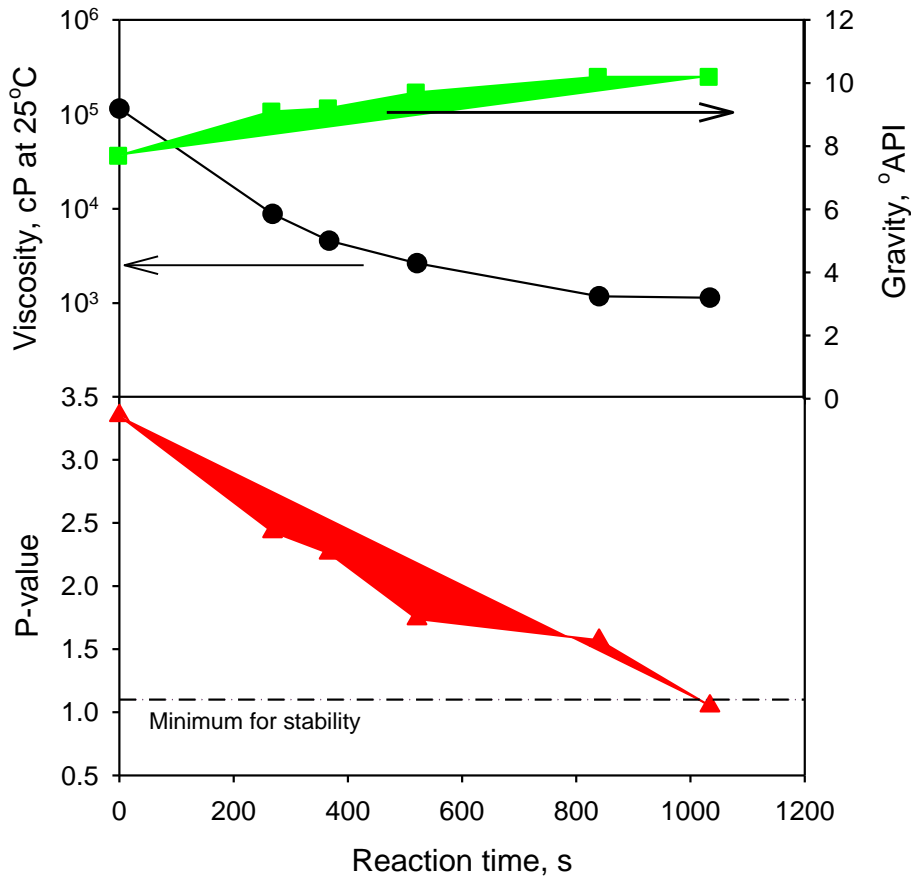


(Chung, et al., 1998)

The activation energy for thermal cracking of vacuum residue is in the range 200-250 kJ/mol, which is consistent with a free-radical chain reaction mechanism (Nelson, 1958), (Gray, 2015)). Once the conversion of vacuum residue exceeds approximately 20-30%, coke formation can be a significant operating problem (Nelson, 1958), depending on how the heat is provided to the reacting liquid. The time to achieve 20% conversion ranges from approximately 1 hour at 365°C to less than 10 minutes at 400°C.

The data of Figure 4.4 illustrate how the properties of bitumen change with thermal cracking without formation of insoluble solids. As shown in this figure, viscosity is reduced significantly over time, but the API gravity of the oil increases only slightly. The lowest viscosity obtained in this example was still too high for pipeline transport, and the API gravity was still much too low.

Figure 4.4: Effect of Thermal Cracking on the Properties Athabasca Bitumen



(Rahimi, et al., 2001). Experiments were in a laboratory batch reactor at maximum temperatures from 423-449 °C. The reaction time is given as equivalent time at 427° C<sup>2</sup>.

Thermal reactions alter the properties of the asphaltene components, so that they become less stable in the product oil. The stability of asphaltenes is measured by titrating the sample with the paraffin n-heptane until precipitation is observed, and the result is expressed as the peptization value or P-value. Peptization is defined as the dispersion of sub-micron sized particles, or “colloids” in a liquid, which in this case is the dispersion of asphaltenes in the crude oil. A P-value of 1.0 indicates that the asphaltenes are on the verge of precipitation without adding any n-heptane. Higher P-values indicate more stability.

In the example shown in Figure 4.4., the unreacted bitumen has a P-value of 3.4 so that it would be stable in a mixture with up to 80% diluent. In contrast, the product at the highest reaction time

<sup>2</sup> In Figure 3.3,  $Equivalent\ time = time \cdot \exp\left(-\frac{E_a}{R} \cdot \left(\frac{1}{T+273} - \frac{1}{700}\right)\right)$ , with  $E_a = 50.1$  kcal/mol and  $R = 1.987$  cal/mol/K



has a P-value of only 1.05, which would begin to precipitate material when mixed with only 25% diluent (Rahimi, et al., 2001). The minimum recommended P-value is 1.1 in refinery practice (Rahimi, et al., 2001). The key point is that too much thermal cracking of bitumen gives unstable products even before coke begins to form. The result is that this processed bitumen may be incompatible with diluent or with refinery streams. These data show why thermal cracking by itself cannot achieve pipeline specifications without addition of some diluent. The primary goal for partial upgrading of bitumen is to economically meet pipeline specifications with reduced or no addition of diluent.

The main driver for thermal cracking is temperature. The weakest bonds in bitumen begin to break in the range of 250°C, giving rise to the formation of detectable hydrogen sulfide. At 350°C the rates of cracking weak carbon-carbon bonds are more pronounced, so that short residence times of a few minutes at this temperature are considered the limit for distillation with minimal alteration of the feed.

Pressure has little effect on the reactions in the liquid phase, because the liquid density is only changed significantly at pressures well over 3,000 psia (21 MPa), the normal upper limit for refinery processing. The combination of pressure and reactor configuration can, however, have a significant impact on the outcome of the thermal reactions, when the thermal cracking is carried out in a continuous process. Higher pressure operation suppresses the formation of the vapor phase, which reduces the formation of light olefin products such as ethylene, and increases the residence time of the liquid in flow reactors (Langer, et al., 1962).

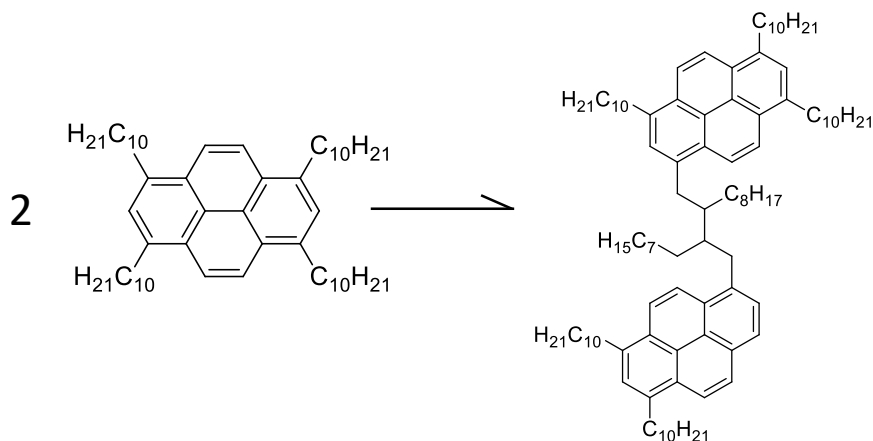
Reactor design can allow the separation of liquid and vapor phases, so that the vapor phase is subjected to much shorter reaction times than the liquid phase. Addition of gases such as steam further enhance the vaporization of lighter components at a given pressure, and can reduce the time available for reaction in both liquid and vapor phase by increasing the velocity of fluids in process furnaces. Steam can be used to sweep the vapors out of a reactor to give much shorter reaction times for the vapor phase than for the liquid phase and thereby reduce over-cracking and olefin formation in the vapor phase.

#### **4.5.2 Addition reactions**

Although the temperatures that produce thermal cracking of bitumen favor the cracking of chemical bonds to give lighter products, reactions in the liquid phase always progress to give larger molecules via addition reactions. Due to the complexity of the mixture of compounds that comprise bitumen, these reactions are exceedingly difficult to track directly, but they are easily identified in reactions of representative pure compounds at the same conditions (Gray, 2015). An example of this type of reaction is illustrated in Figure 4.5., which shows an actual reaction based

on experimental data. In this case, the product has almost twice the molecular weight of the reactant.

**Figure 4.5: Example: Addition Reaction of a Model Bitumen Component.**



(Alshareef, et al., 2011) Addition products were 40 wt% of the total products of reaction at 420°C after 20 minutes

These reactions result in formation of less soluble material in the bitumen, which is detected as asphaltenes (heptane insoluble) and coke (toluene insoluble). These solubility characteristics are a major factor in coke formation, which is covered in Section 4.5.4 below.

### 4.5.3 Hydrogen transfer reactions

Thermal cracking reactions tend to redistribute hydrogen. The light cracked products from bitumen tend to be richer in hydrogen than the initial mixture, so that the liquid phase becomes more depleted in hydrogen as the reactions proceed. Within the liquid phase, components can donate hydrogen by undergoing reactions that release hydrogen. For example, partly hydrogenated aromatic compounds give up hydrogen to form more aromatic products (lower H/C ratio). The hydrogen that is released has been observed to saturate olefins at 270-310°C in the liquid phase (Ruchardt, et al., 1992).

Hydrogen donor compounds are naturally present in the vacuum residue and asphaltene fractions of bitumen, but the exact concentrations of donatable hydrogen are difficult to measure. Estimates range from 10% of the total hydrogen content (Rahmani, et al., 2002) to 30% (Gould, et al., 2007)), although the latter value is too high based on data for the types of hydrogen present (Gray, 2015).

Athabasca asphaltenes are able to transfer measurable hydrogen at temperatures as low as 100-150°C, and give conversion of olefins at 250°C (Naghizada, et al.) . The quantity of hydrogen transferred was about 5% of the total hydrogen content.

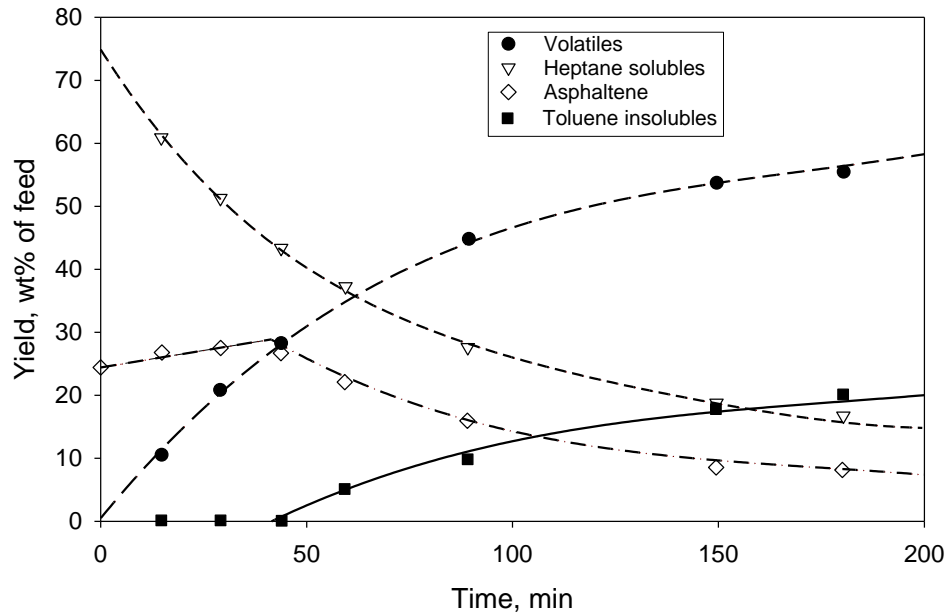
Augmenting the natural hydrogen donor capacity by adding partly hydrogenated aromatic compounds gives benefits during thermal cracking (Langer, et al., 1961)). These streams can both act as hydrogen donors and enhance the solubility of asphaltenes. The result is suppression of solids or coke formation at a given reaction time and temperature. When the stability of the product oil limits conversion, the addition of hydrogen donors allows more conversion, which can achieve lower viscosity and still maintain the P-value within an acceptable range. (Langer, et al., 1962)

#### **4.5.4 Coking**

If thermal cracking continues past the point where asphaltenes are no longer stably dispersed in the crude oil, they begin to precipitate from the oil and form a new phase, commonly called coke (Wiehe, 1993). The coke material can attach to the surfaces of process equipment, causing severe fouling and plugging. While coke can be plastic at high temperature, it is a solid at normal temperatures.

The progress of coke formation is illustrated in an open reactor in Figure 4.6. The concentration of asphaltenes increases with time for the first 45 min, then begins to fall as toluene-insolubles, or coke, begins to form. The delay of the onset of coke formation is called the induction time.

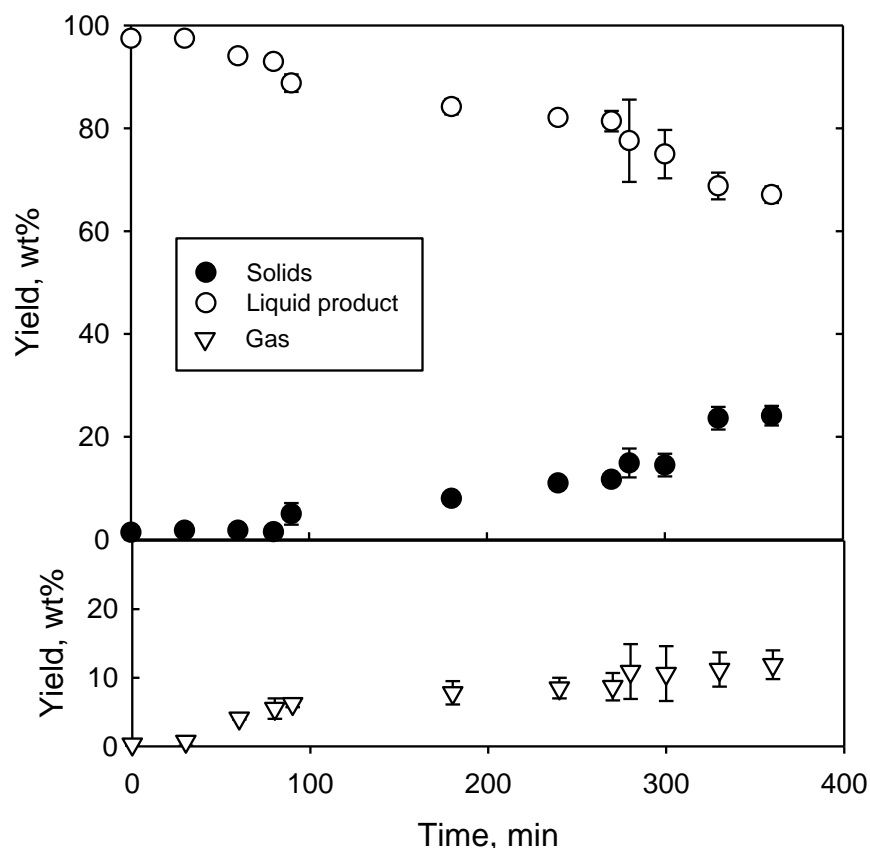
Figure 4.6 Thermal cracking of Cold Lake Vacuum Residue at 400°C



(Wiehe, 1993) Data are from reaction in an open reactor which allows evolution of gas and vapor, reported here as volatiles. Smooth curves are from a kinetic model for thermal cracking and coke formation.

When the more volatile components are retained in the reactor, more and more gas formation occurs (Figure 4.7), which in cracking of petroleum is defined as gases at ambient temperature and pressure. These gases include methane, ethane, ethylene, propane, propylene, butylenes, and some butane, along with low concentrations of hydrogen, carbon monoxide and carbon dioxide.

Figure 4.7: Thermal cracking of Athabasca bitumen in a closed reactor at 400°C



(Zachariah, et al., 2016) Solids yields are net formation of filterable material, subtracting the mineral solids present in the initial bitumen.

The data of Figure 4.7 show three distinct phases of solids formation: an initial induction period that is around 80 minutes in duration where very small amounts of solids are formed, linear formation from 80 min to around 300 min, then a significant increase in solids yield starting at 300 min of reaction. The duration of the induction period was longer than on Figure 4.6 for Cold Lake Vacuum Residue, which illustrates that the onset of coking is a function of the composition of both the liquid phase in the reactor and the reacting asphaltene material.

The formation of almost 12% gases, which are rich in hydrogen, gave liquid and solid products that were depleted in hydrogen relative to the initial bitumen. The H/C ratio of the liquid product dropped from 1.455 mol/mol at time zero to 1.06 at 360 min.

If the coke formation occurs in a controlled fashion within a reaction vessel, then this mechanism provides a means to continue cracking the heavy components of the vacuum residue to obtain

very high conversions. In this case the conversion of the vacuum residue fraction to coke, lighter liquid fractions, and gases can approach 100%.

A large number of studies show that coke forms most easily from the asphaltene fraction, so that partial or complete removal of the asphaltenes will significantly reduce the formation of coke. An example is given in Table 4.3, for a whole vacuum residue and two deasphalted samples. The yields of coke and asphaltene are given after thermal cracking at 420 °C for one hour.

**Table 4.3. Formation of Asphaltenes and Coke from Fractions of Vacuum Residue\*.**

Composition	Whole vacuum residue	C <sub>7</sub> soluble, deasphalted with heptane	C <sub>5</sub> soluble, deasphalted with pentane
Initial C <sub>7</sub> -asphaltenes, wt%	9.4	0	0
Initial C <sub>5</sub> -asphaltenes, wt%	12.6	3.5	0
Initial C <sub>5</sub> soluble-C <sub>7</sub> insoluble, wt%	3.2	3.5	0
Final toluene-insoluble coke, wt%	2.1	0.0	0
Final C <sub>7</sub> -asphaltenes, wt%	15.5	13.6	6.0

Reference: (Avid, et al., 2006).

\*Reaction conditions: 20wt% solution of sample in 1-methylnaphthalene, react at 420C for 1 hour. Vacuum residue from a Middle East crude oil. Weight fractions are for weight of initial sample

Removal of the C<sub>7</sub>-asphaltenes eliminated the formation of coke, but due to addition and other reactions, significant amounts of asphaltenes were formed. The removal of the C<sub>5</sub>-insoluble asphaltenes resulted in much less asphaltene formation. These results suggest that material that is soluble in heptane but insoluble in pentane may play an important role in the formation of asphaltenes during thermal cracking. Several process technologies for partial upgrading remove portions of the asphaltene fraction (see Chapter 5.4.3). The contribution of these different fractions to coke formation and generation of more asphaltenes during thermal cracking is an important fundamental knowledge gap.

#### **4.5.5 Scale-up of thermal cracking processes**

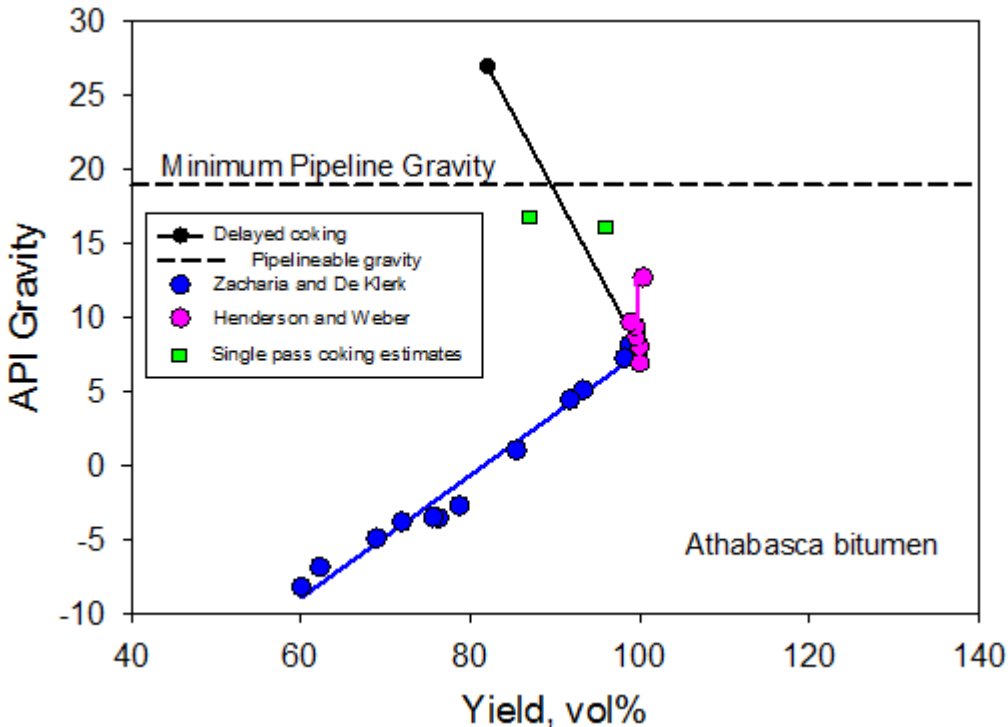
The data presented in this section on the fundamentals of bitumen reactions are derived from idealized conditions, in laboratory reactors that use either intense mixing by impellers or very small scale (a few millilitres of liquid) to achieve uniform temperatures. Under these conditions, the temperature of the reacting liquid in the bulk is very similar to the reactor walls.

When thermal cracking is conducted at a larger scale, as in pilot plants or demonstration plants, these conditions no longer apply. Heating of bitumen in process furnaces can give wall temperatures that are significantly higher than the bulk liquid, giving localized reaction conditions with coke formation even as the bulk fluid is just beginning to react. Such localized conditions can give rise to fouling of surfaces and formation of solids even when the temperatures might appear safe in the bulk liquid. Continuous reactor operation tends to cumulate these effects with time of operation, so that fouling that may not be detected in a batch laboratory reactor can shut down a continuous process in a matter of hours.

#### **4.5.6 Boundaries on thermal cracking**

The trends in product yield and API gravity can be illustrated by plotting the results of reactions or upgrading processes on a x-y plot of gravity versus volumetric yield (Gray, 2002). The target for partial upgrading technologies is to achieve pipelineable density and viscosity with minimal loss of liquid yield. Data for thermal cracking is illustrated in Figure 4.8.

Figure 4.8: API gravity and yield from thermal cracking of Athabasca bitumen



Data are for cracking at 400°C (Zachariah, et al., 2016) with gravity estimated from refractive index (Yarranton, et al., 2015), at 263-371°C (Henderson, et al., 1965) estimated data for single-pass coking at 530-550°C (Soskind, et al., 1962), (Brown, 2009)) and delayed coking (Gray, 2002).

The data illustrate that mild thermal cracking alone does not significantly change the gravity of the product. All but one product reported by Henderson and Weber (Henderson, et al., 1965) had a gravity within 3 °API of the feed, similar to the data presented in Figure 4.1. Without the removal of dense components or elements, breaking of bonds alone does not significantly change the density of the liquid product. The formation of dense insoluble solids, such as coke, which is removed from the liquid product, can provide a means of changing the density. This is illustrated in Figure 4.8 for single-pass coking, which achieves around 80% conversion of vacuum residue, and delayed coking, which achieves 100% conversion. The latter process exceeds the required specifications for partial upgrading.

The data of Zachariah and de Klerk illustrate that formation of solids alone does not guarantee lighter liquid products (Zachariah, et al., 2016). In their closed reactor, gas yields were significant and the liquid likely underwent significant addition reactions. The combination of loss of hydrogen to the gas components and increasing molecular weight in the liquid, gave consistently denser products than the initial bitumen, and illustrates a very undesirable trend for a partial upgrading process.



## 4.6 Catalytic Cracking

Catalysts with strong acidity have the capacity to accelerate cracking of carbon-carbon bonds in petroleum materials, and these materials are widely used in processing of distillates. The vacuum residue components of bitumen, however, are rich in nitrogen compounds, which strongly suppress the activity of these catalysts and often result in irreversible deactivation, and formation of high-boiling compounds that react to form coke on the catalyst surface. The lifetime of acid catalyst materials when exposed to bitumen is so short that they act as one-time adsorbents rather than economic catalysts. Consequently, catalytic cracking can only be applied to heavy bitumen fractions if the severe deactivation is controlled. Examples are processing only a small fraction of bitumen vacuum residue with gas oil feed in fluid catalytic cracking, or using high-pressure hydrogen in hydrocracking of deasphalted and hydrotreated material. The opportunity for partial upgrading of bitumen is to produce more acceptable feeds for catalytic cracking in refineries.

## 4.7 Catalytic Hydrogenation

Catalysts based on metal sulfides, particularly molybdenum-nickel blends, are very effective for hydrogenation of sulfur, nitrogen, and metal-bearing compounds, and for hydrogenation of aromatic compounds and olefins. These reactions are the basis of commercial hydrotreating processes. Reaction conditions range from very mild, for conversion of diolefins in cracked products, to very severe for removing sulfur from vacuum residues (Topsoe, et al., 1996) (Yui, 1999).

The addition of metal sulfide catalyst and high-pressure hydrogen during thermal cracking reactions enables much more conversion of vacuum residue components without the formation of coke. This combination of conditions results in hydrogenation of all olefin products from thermal cracking, which suppresses their addition reactions (Habib, et al., 2013) and prevents coke formation (Gray, et al., 2002).

## 4.8 Other Catalytic Cycles

### 4.8.1 Sodium-Sodium Sulfide Cycle

Metallic alkali metals, such as sodium and lithium, are strong reducing agents that react readily with organic sulfur compounds and hydrogen to produce sulfur-free hydrocarbons and sodium sulfide. (Sternberg, et al., 1974), (Verkade, et al., 1999), (Field\_Upgrading, 2015)). A small amount of hydrogen gas is required at low pressure to ensure that the fragments of bitumen do not undergo addition reactions after the sulfur is removed. A catalytic cycle can be established if the sodium sulfide is separated from the reaction products and reduced to regenerate the sodium

metal (Brons, et al., 2001)). Removal of sulfur is accompanied by significant removal of metals, conversion of vacuum residue, reduction in density, and reduction in viscosity.

#### **4.8.2 Carbon Oxidation-Water Reduction**

The direct use of water as a source of hydrogen is highly desirable, but extremely challenging due to the thermodynamic stability of water. Gasification reactions at high temperature, over 600°C, result in reaction of carbon-rich solids like coal and coke with steam to produce carbon dioxide and hydrogen. A number of studies have attempted to use this type of chemistry with liquid hydrocarbons and bitumen. The most successful approach is to use catalysts to establish a redox cycle to transfer the oxygen from water to carbon, forming carbon dioxide, and thereby enable the incorporation of hydrogen from water into the oil (Fumoto, et al., 2009), (Fumoto, et al., 2015). The approach has been demonstrated for iron oxide supported on titanium dioxide powder. Data for dispersed particulate catalysts have also given some evidence for increased carbon dioxide formation, but in lower amounts (Fathi, et al., 2011)

In the absence of a catalyst, the effect of adding water to thermal cracking reactions is to add a solvent which alters the phase behavior of bitumen components (Cheng, et al., 2009). Lower molecular weight species in bitumen readily dissolve in liquid water at high-pressure or supercritical conditions (Watanabe, et al., 2010), (Vilcaez, et al., 2012) and the solubility of water in heavy bitumen fractions increases dramatically with temperature (Amani, et al., 2014). Although water exchanges isotopes with bitumen under thermal cracking conditions, the available scientific papers do not suggest significant net transfer of hydrogen (Cheng, et al., 2009)).

#### **4.8.3 Other Process Pathways**

The current industry practice is to use heat to initiate the cracking reactions of bitumen fractions, leading to operation in the range of 360-550°C as discussed above. These temperatures are sufficient to break a very small fraction of weak bonds in the bitumen, which in turn begins chain reactions that give significant conversion.

##### **4.8.3.1 Ionizing Radiation**

Other techniques can create active reactive species in bitumen, including ionizing radiation (e.g. beams of electrons or gamma rays (Soebianto, et al., 1992)), and contacting with hydrogen plasma (Rahimi, et al., 1998)). In order for these reactive species to give measurable conversion, the temperature of the bitumen must be high enough to thermodynamically favor cracking reactions (Raseev, 2003)), and to support chain reactions at useful rates. Consequently, these schemes would need to operate at comparable temperatures to conventional thermal processes, as demonstrated on hydrocarbons (Soebianto, et al., 1992)

#### 4.8.3.2 Fluid-Mechanical Alteration

A number of patents have proposed the use of cavitation from sonication or fluid expansion from jets to cause reactions and structural changes in heavy bitumen fractions (Duyvesteyn, et al., 2011), (Kostrov, et al., 2011)). The collapse of bubbles during cavitation can give tiny hot spots with temperatures over 3,000°C that initiate reaction (Thompson, et al., 1999). However, at low temperature of the bulk liquid, the rate of conversion of hydrocarbons is insignificant and addition or polymerization reactions are favored (Suslick, et al., 1983), (Cataldo, 2000). Like ionizing radiation, significant conversion would require operation at temperatures comparable to conventional thermal processes. Shear forces in liquids can break high molecular-weight polymers (Kuijpers, et al., 2004) and DNA (Bowman, et al., 1972).

The molecular components of bitumen are all below a molecular weight of 3,000 (McKenna, et al., 2013), (Chacón-Patiño, 2017), which is much lower than the molecular weight of polymers, which are over 1 million and can be broken by fluid forces. The largest aggregated species in bitumen are the asphaltene aggregates, which are in the range 2-20 nm (Yarranton, et al., 2013)), and are also smaller than the size of polymers that break due to cavitation shear.

A combination of cavitation, heating to temperatures known to cause thermal reactions, and heating under pressure may result in partial upgrading, but the contribution of cavitation against the background effects of thermal reactions at elevated pressure is extremely difficult to assign unambiguously.

#### 4.8.3.3 Oxidative Desulfurization

Oxidative desulfurization can be used to reduce the sulfur content of crude oils by converting sulfur species into the corresponding sulfoxides and sulfones, which are removed by extraction or adsorption. The amount of material removed depends on the molecular weight of the species containing the sulfur, the number of sulfur molecules on the species, and the solubility properties of the reacted material.

We can examine the impact of oxidative desulfurization for a typical bitumen. Assume the bitumen contains around 5 wt% sulfur and has a molecular weight of around 582 g/mole (Lu, et al., 1989), (Agrawal, et al., 2012). This gives an average ratio of 0.87 moles sulfur per mole of bitumen, which means that a typical molecule contains at least one sulfur. If there is one sulfur atom on each typical molecule, removal of half of the sulfur requires removing around 40 wt% of the bitumen.

In the asphaltene fraction, the average molecular weight is higher, approximately 2,000 (Agrawal, et al., 2012), and the sulfur content is higher at 6.5 wt%. Conversion of 50% of the sulfur would convert at least one sulfur per molecule to a polar sulfoxide or sulfone. Such oxidation of bitumen

generates more material that will not dissolve in heptane, nominally asphaltenes (Moschopedis, et al., 1977). These high density, oxidized products are unlikely to give efficient removal by extraction into water or by adsorption. The combination of high molecular weight and polar sulfur species could result in almost complete conversion to highly insoluble surface-active solids that dissolve in neither hydrocarbon solvents nor water. Such oxidation products would cause serious problems with attempts to extract the rest of the oxidized sulfur species from the bitumen into an aqueous solution. The combination of large losses of oxidized sulfur species and potential insolubility of products makes oxidative desulfurization better suited to removing low levels of sulfur, as a polishing step for distillates rather than bulk desulfurization of high density materials.

In order to minimize the serious loss of yield, the sulfones and sulfoxides would need to be reacted to remove the sulfur. Such chemistries have not been demonstrated on heavy bitumen fractions.

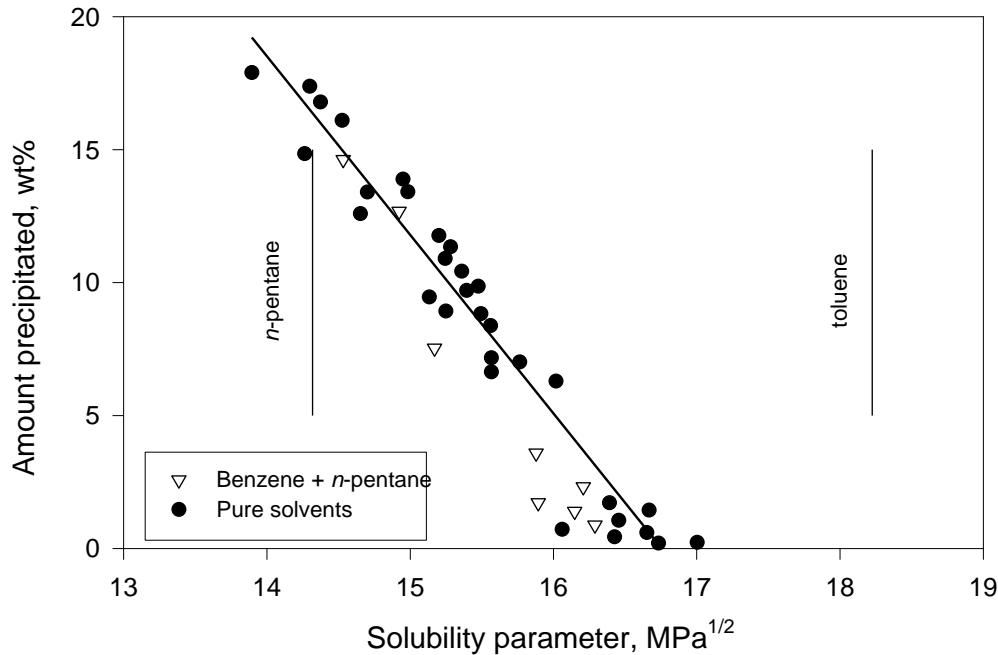
#### **4.9 Separations to Improve Properties and Market Value**

Two types of separation technology are commonly used in petroleum processing; distillation and solvent deasphalting. Distillation under vacuum can remove up to half of the bitumen, which is useful in processing of fractions in an upgrading or refining plant, but not by itself as a means of partial upgrading.

In solvent deasphalting, paraffinic solvents such as propane, butane, pentane or hexane are used to precipitate the least soluble components of the vacuum residue, either as a liquid phase or as a solid depending on the solvent used and the temperature. By selection of solvent and solvent-bitumen ratio any desired amount of precipitation can be observed, from 1% up to 50% of the initial bitumen (Brons, et al., 1995), (Gray, 2015).

For example, the data of Figure 4.9 show that a range of material can be precipitated from Athabasca bitumen depending on the choice of solvent. If solvents such as butane or propane are used, which are weaker than pentane, then the trend continues to the upper left in the plot in Figure 4.9, and larger and larger amounts of material is precipitated. The precipitate is rich in asphaltenes, which are the densest fraction of crude oil with the highest concentrations of sulfur, nitrogen, and metals. The asphaltenes also have the highest yield of MCR.

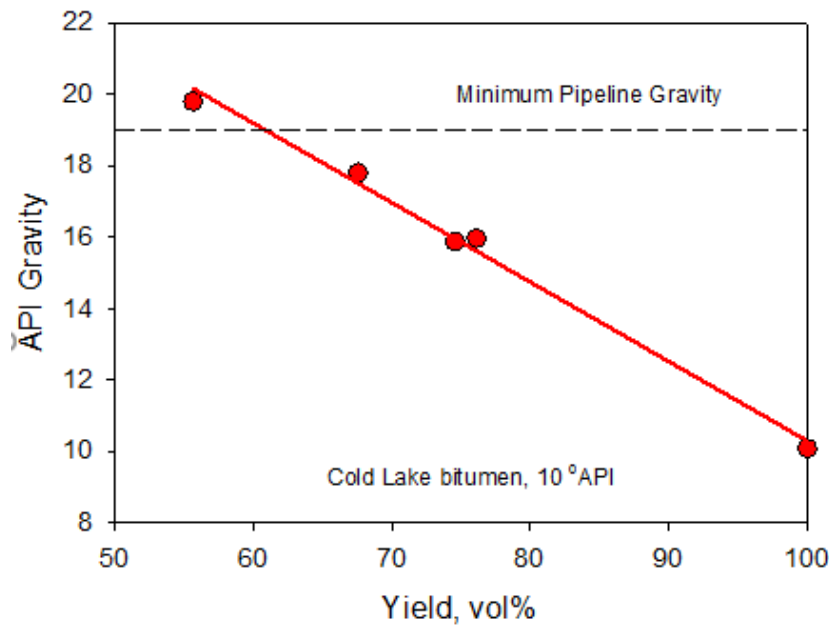
Figure 4.9: Precipitation of Asphaltene Components as a Function of the Solubility Parameter of the Liquid Phase



(Mitchell, et al., 1973). Data are for Athabasca bitumen at 20°C and a 20:1 ratio of solvent to bitumen. The Hildebrand solubility parameter is tabulated for different solvents (Barton, 1991)).

Consequently, the precipitation of asphaltene components produces a product of lower density with reduced MCR, sulfur, nitrogen and metals, as illustrated in Figure 4.10. The density of deasphalted bitumen is reduced (API gravity increases) as a result of removing material via solvent deasphalting, and the diluent requirement to meet pipeline specifications is reduced. At the same time that the yield of bitumen is reduced, the yield of asphaltene by product is increased, which must be sold or disposed of in some way.

Figure 4.10: Yield and Gravity of Product Oil from Solvent Deasphalting



( (Brons, et al., 1995)) Data for Cold Lake bitumen from deasphalting with butane and pentane.

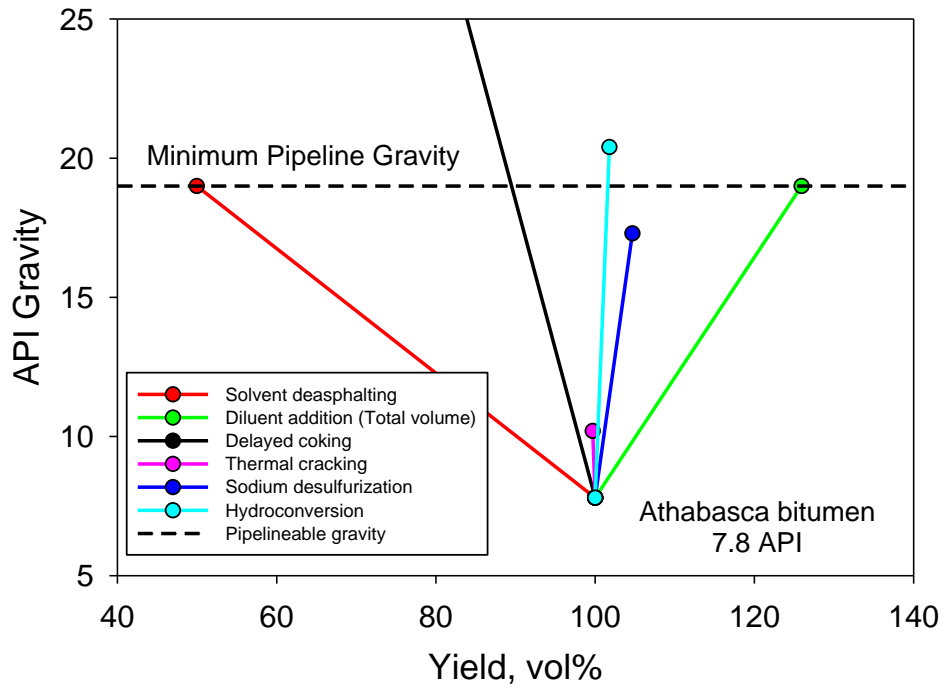
#### 4.10 Feasible Range of Partial Upgrading Products

Given the range of possible reactions and separation processes that can be applied to bitumen to achieve partial upgrading, the technically feasible space for potential upgrading operation can be defined. Figure 4.11 shows the potential range of options to meet pipeline viscosity specifications.

The default option for a SAGD producer is to add diluent and ship the product, at the cost of transportation as discussed in Section 2. This option allows selling 100% of the bitumen product, plus the volume of the purchased diluent; the diluent component in dilbit is sold at a discount to its purchase price. At the opposite extreme is solvent deasphalting, which removes the denser asphaltenes and other components from the bitumen, but can only achieve pipeline gravity at the expense of removing approximately half the initial bitumen (Brons, et al., 1995). Similarly, delayed coking gives gravities higher than 19 API, but the volume yield is reduced due to coke rejection from the process.

The volume of bitumen can also be increased by catalytic reactions with hydrogen gas, giving removal of the dense sulfur and nitrogen atoms, and net addition of hydrogen. This trend is illustrated for two representative processes in Figure 4.11 for sodium metal desulfurization and catalytic hydroconversion.

Figure 4.11: Trajectories for Partial Upgrading Processes Based on Known Process Chemistries.

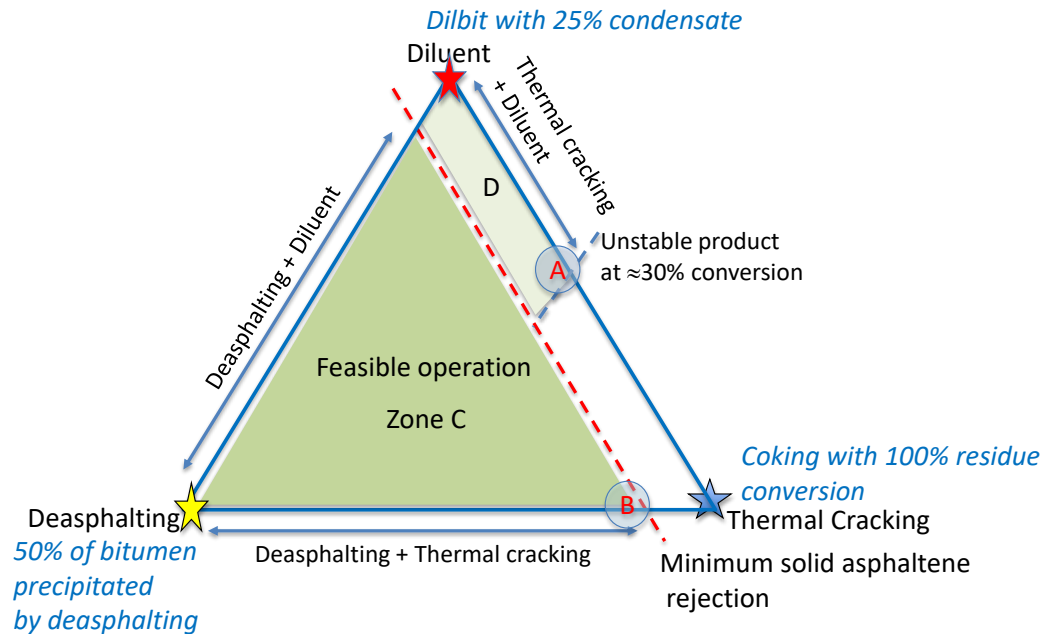


Data are for Athabasca bitumen, and are approximate for illustration of trends in yield versus gravity of product ( (Rahimi, et al., 2001), (Gray, 2002), (Field\_Upgrading, 2015))

#### 4.11 Combinations of Processes

If processes are combined, a larger feasible operating space will open to achieve the desired pipeline specifications. Many combinations are possible, and a number of combinations are discussed in Section 5.4 For example, thermal cracking, addition of diluent, and deasphalting can be combined pairwise to meet pipeline specifications for partially upgraded bitumen. The possible operating space for two- and three-way combinations of these technologies is illustrated in Figure 4.12.

Figure 4.12: Feasible Operating Space for Combinations of Thermal Cracking, Diluent Addition, and Deasphalting for the case of Athabasca Bitumen.



The three extreme cases are delayed coking for thermal cracking, dilbit production by diluent addition, and deasphalting. Operating zones A through D are discussed in the text.

In this triangular diagram, the apices are single technologies to produce pipelineable product from Athabasca bitumen. The top of the diagram is diluent addition to produce dilbit, the right hand apex is delayed coking to give 100% conversion of the vacuum residue fraction, and the left hand apex is deasphalting. The deasphalting apex is the extreme case, based on the data of Figure 4.10, for 50% removal of the bitumen by solvent deasphalting. This approach is not economic, but it is technically feasible.

Each edge of the triangle is a combination of two technologies as indicated. The limit indicated on thermal cracking plus diluent is the formation of incompatible asphaltenes, giving unstable product as illustrated in Figure 4.4. The white zone is excluded because operation is not feasible. Zone A is where the combination of thermal cracking and diluent addition will require the smallest volume of diluent. Zone B is where the combination of thermal cracking and deasphalting will give the highest liquid yield. Zone C is the feasible operating space for combinations of all three technologies.



The minimum limit on solid asphaltene rejection achieved in a commercial process corresponds to precipitation of 8-10% of the bitumen, or 50-65% of the asphaltenes, as demonstrated in the paraffinic froth treatment process. Rejection of less asphaltenes is technically possible, as indicated in Figure 4.9, but has not been demonstrated in commercial operation. Consequently, although operation in Zone D is theoretically possible, it would likely require a new approach to removal of precipitated asphaltenes.

The depiction in Figure 4.12 shows two boundaries within the operating space, but the exact position of these boundaries depends on the details of process design. For example, the minimum limit for deasphalting could potentially be shifted by using new technology for removal of precipitated asphaltenes, or by operating at higher temperature. The boundary on the stability of product from thermal cracking will shift up or down depending on the details of the cracking process conditions. For example, time, temperature and the addition of solvents can shift the boundary. All thermal cracking based technologies, have a limit of the type shown in Figure 4.12.

An equivalent diagram can be drawn for the case of hydroconversion, which uses thermal cracking in combination with hydrogen and a catalyst to suppress coke formation and to maintain a compatible product over a wider range of conversion.

## 5. Bitumen Partial Upgrading and Technology Readiness

We begin with a general overview of the steps required for a functional partial upgrading process, then begin an examination of the bitumen conversion and separation technologies. We review the existing commercial technologies that are relevant to partial upgrading, including the standard reference technology used in the refining industry, which is delayed coking.

New technologies for partial upgrading that are under development by a number of groups seek to address the need for lower cost approaches to produce a partially upgraded bitumen in contrast to the full upgrading operations currently practiced on a commercial scale in Alberta. These technologies are at different stages of development. We therefore provide a classification based on technology readiness level and apply it to the range of technologies proposed for partial upgrading.

Our review of partial upgrading technologies includes a range of information from published sources as available, including block flow diagrams, yields, utility requirements, and environmental impact. In addition, we identify the underlying scientific principles associated with each technology (or gaps in knowledge to fully appreciate the underlying scientific principles and evaluate the utility of the technology). We cross reference to supporting literature and identify possible R&D activities that could reduce the technical risk of these technologies.

### 5.1 Partial Upgrading Overview

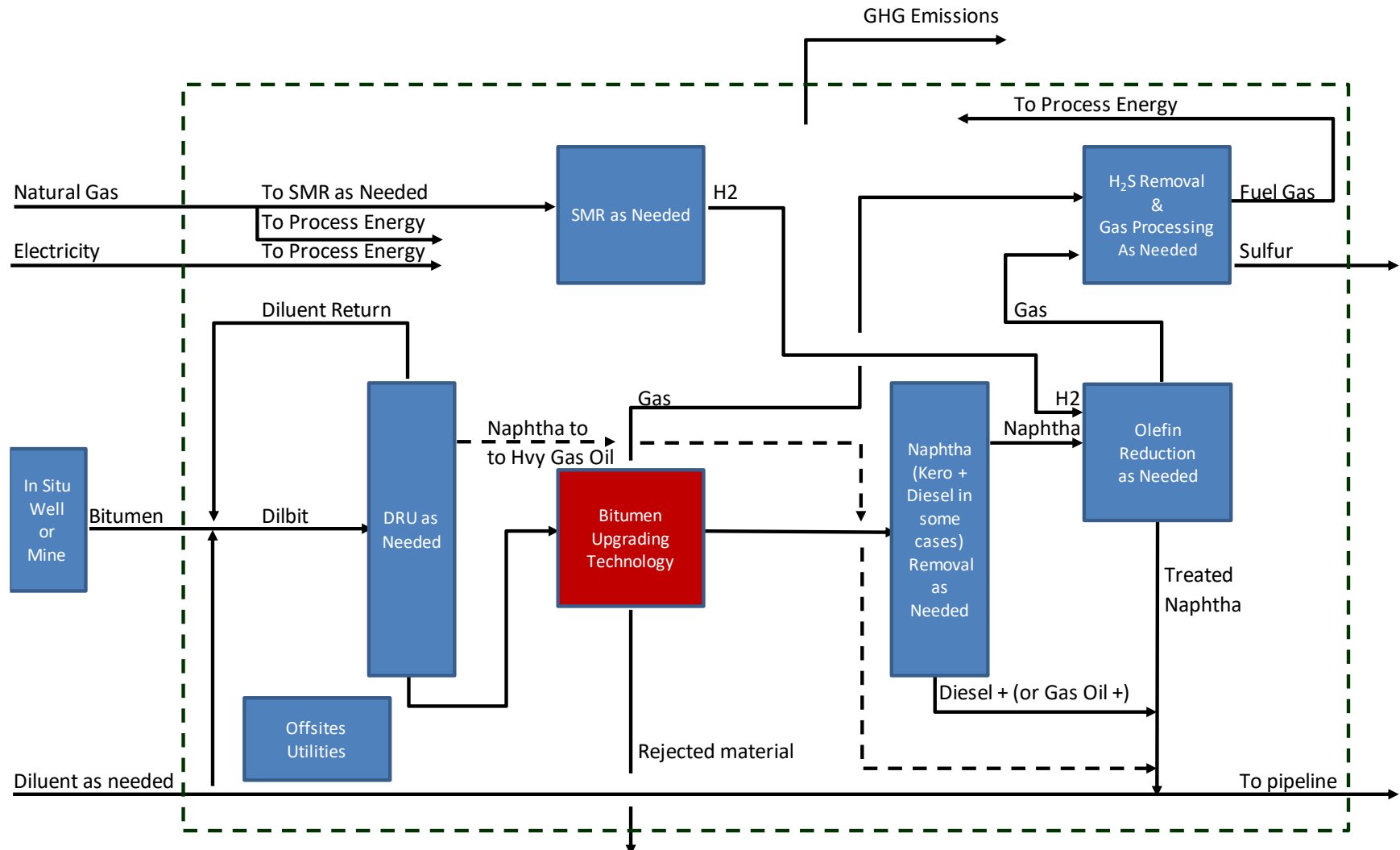
A schematic of the steps from bitumen production to upgraded products is shown in Figure 5.1.

Starting on the left in Figure 5.1:

- Bitumen from a mine or in situ production facility is blended with diluent for transport
- Diluent is removed from bitumen in the DRU (diluent recovery unit) and returned to the production site
- The DRU can be designed to remove only diluent or also lighter material leaving only the heavy residue for upgrading
- Gas from bitumen upgrading is sent to the gas plant for clean-up, including sulfur removal
- Treatment of some or all of the products from bitumen upgrading to remove olefins may be necessary to meet pipeline specifications
- Olefin treatment may be done via hydrotreating or other process
- Products from olefin removal are combined with the other products from bitumen processing and products that bypass upgrading

- Diluent must be added to meet pipeline specifications for viscosity and density if upgrading does not make sufficient improvement in these properties
- If hydrogen is used in olefin removal, a hydrogen plant is needed that converts natural gas to hydrogen via steam methane reforming (SMR)
- Offsites-utilities section includes a steam plant, water treatment plant, sulfur plant, etc. as needed

Figure 5.1: Block Process Diagram of a Partial Upgrading Plant



## 5.2 Upgrading Technology Classification

Bitumen upgrading technologies can be classified into four major categories:

1. Thermal cracking – breakup large molecules in bitumen using heat
2. Hydrogen addition and cracking – add hydrogen to molecules during bitumen upgrading combined with breakup of large molecules
3. Asphaltene separation – remove refractory, difficult to convert components using their solubility properties
4. Fluid mechanical – breakup aggregations of molecules in bitumen using mechanical forces

The first three of these technology types are available as commercial technologies, and examples are in use in Alberta. The commercial hydrogen addition technologies exceed the requirements for partial upgrading, therefore, these processes are not discussed further. Descriptions are provided in Appendix E. We discuss the remaining major technology classifications below and highlight technologies that are practiced commercially. Some upgrading technologies include more than one of these four technology classifications.

Several new approaches have been proposed which do not fit this classification, and these will be described in Section 5.4.7.

### 5.2.1 Thermal Processing

The two most commonly used commercial variants of thermal processing for crude oil are visbreaking, and coking. These processes rely on thermal decomposition of some or all of the oil being processed with visbreaking being the mildest form and coking being more extreme.

#### 5.2.1.1 Visbreaking

Visbreaking (*viscosity reduction, viscosity breaking*), developed in the late 1930s, is a mild form of thermal cracking of vacuum residue that produces more desirable and valuable products and fuel oil that meets viscosity specifications. Visbreaking relies on mild thermal reaction in contrast to delayed coking, which uses much longer residence times and allows thermal reactions to proceed to completion.

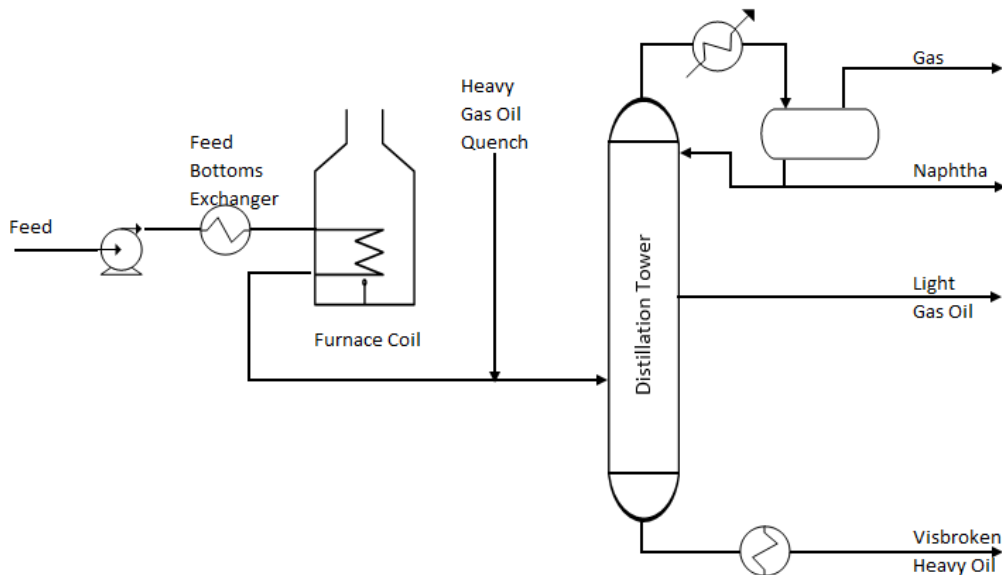
Visbreaking occurs predominantly in the liquid phase at temperatures ranging from 455 to 510 °C (850 to 950 °F) with short residence times and pressures from 50 to 300 psi at the heating coil

outlet. The major process variables are (1) feedstock type, (2) temperature, (3) pressure, and (4) residence time, which controls the extent of cracking.

Feedstock (residue or bitumen) is passed through a furnace where it is heated to 480 °C (895°F) under an outlet pressure of about 100 psi. Liquid-phase thermal cracking under these low-severity conditions produces some naphtha, kerosene and gasoil boiling range materials that are removed as overhead using a flash-distillation chamber. Liquid products from the flash chamber are cooled with a gasoil flux and can be sent to a vacuum fractionator for further separation to produce a heavy gasoil distillate and a residue of reduced viscosity. Conversion of 5%–10% of the residue feed to naphtha is usually sufficient to reduce the viscosity in the residue product by a factor of five compared to the viscosity of the residue feed to the visbreaking process.

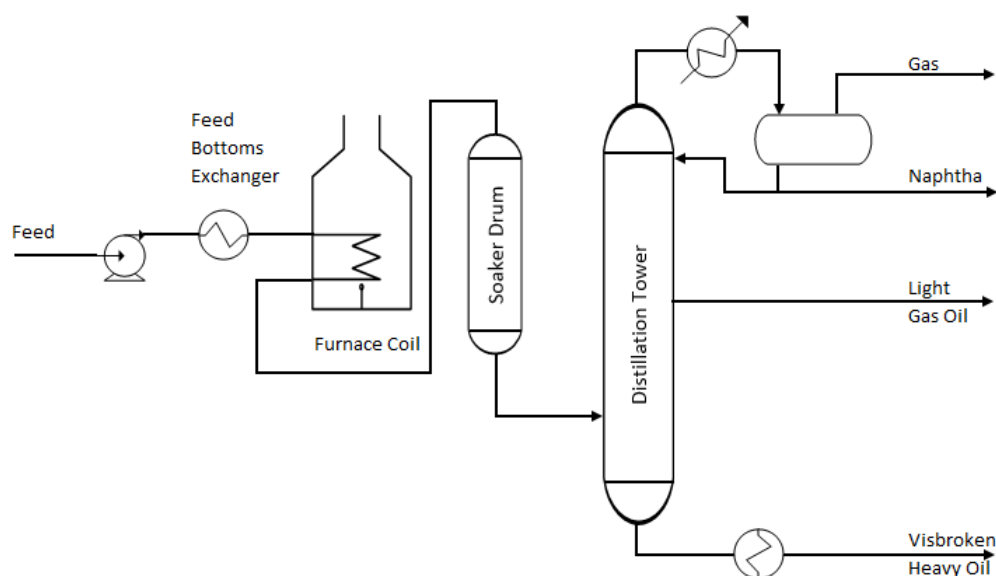
There are two general types of visbreaker design: coil and soaker. Visbreaking reactions are carried out at contact times of a few minutes in furnace coil tubes of a coil type visbreaker (simplified schematic in Figure 5.2) or in longer residence time in a soaker-type visbreaker (simplified schematic in Figure 5.3). Furnace inlet pressure must be sufficient to keep gasoil and heavier reaction constituents in the liquid phase at the furnace outlet (generally around 150-300 psi). The limit on reaction temperature is set by the desired severity of cracking, which depends on the visbreaker feed composition and the need to maintain a stable fuel oil product.

Figure 5.2: Coil Type Visbreaker Schematic



(Beccari, et al., 2006) – redrawn

Figure 5.3: Soaker Type Visbreaker Schematic



(Beccari, et al., 2006) - redrawn

Stability of the heavy oil product is a critical aspect of visbreaker operation, as discussed in Section 4.5.6. Feed asphaltenes are stabilized by the aromatic components in the feed so they are dispersed as colloids. Visbreaking converts vacuum residue to lighter products and produces additional asphaltenes by polymerization reactions. Most feed asphaltenes undergo little or no change in visbreaking and are often described as refractory or difficult to react.

As the severity of visbreaking increases and vacuum residue are converted, there is insufficient peptizing capability from the liquid phase to keep the asphaltenes in colloidal dispersion. Asphaltenes are mutually attracted and flocculate, resulting in an unstable heavy oil product from visbreaking. The severity at which asphaltenes flocculate depends on the composition of the feed to the visbreaker, which depends on the crude oil characteristics. The type of cutter stock used in fuel oil blending, to reduce viscosity, also affects fuel oil stability.

Fuel oil stability can be measured using a P-value (Peptizing value) test: P-values less than or equal to 1.0 indicate the fuel oil is unstable; P-values between 1.0-1.1 indicates borderline fuel oil stability; P-values greater than 1.1 indicate a stable fuel oil.

Milder cracking conditions can be achieved by lowering the temperature in the furnace and using a soaking drum between the furnace and the fractionator to enable longer residence time at temperature. Mild cracking conditions (low feedstock conversion per pass through the heater) result in higher yield of naphtha with low gas production and decreased coke production.

However, mild cracking results in lower conversion of higher boiling residues which must be recycled through the heater and can result in increased yield of refractory material.

Decoking is not as frequent with soaker drum visbreaker designs as with coil-type visbreaker designs. However, the soaker design requires more equipment for coke removal and handling. Coke removal from the drum requires cutting it out with high-pressure water, which results in significant amount of coke laden water that must be filtered for reuse.

Due to the limitations on the stability of the product, commercial visbreaking processes cannot convert bitumen into a product that meets pipeline specifications. In principle, visbreaking of bitumen could be used to reduce the amount of diluent required to meet pipeline specifications, but this combination has not been adopted in Alberta. The only visbreaker to operate in an upgrader in Alberta was at the Nexen Long Lake Plant, where it was used to obtain conversion of vacuum residue prior to a deasphalting process. The basic approach of visbreaking, which is mild thermal conversion of a portion of the bitumen, is attractive and features prominently in proposed partial upgrading processes in Sections 0 and 5.4.3.

#### **5.2.1.2 Coking**

In coking processes, residue is heated to high temperatures (450-500 °C). Light boiling products distill overhead leaving solid coke behind. Coking is the most popular conversion choice for resids that are high in asphaltene cores (low hydrogen, high heteroatoms, and high MCR) because coking reactively separates asphaltene cores into a low value byproduct (coke) leaving the resins for further upgrading. Coking is an extreme form of thermal cracking with carbon rejection. By rejecting refractory carbon-rich material, which is high in metals and sulfur, coking enables the remaining products to be readily processed in most petroleum refineries. The mechanism and time course of the coking reactions was discussed in Section 4.5.4.

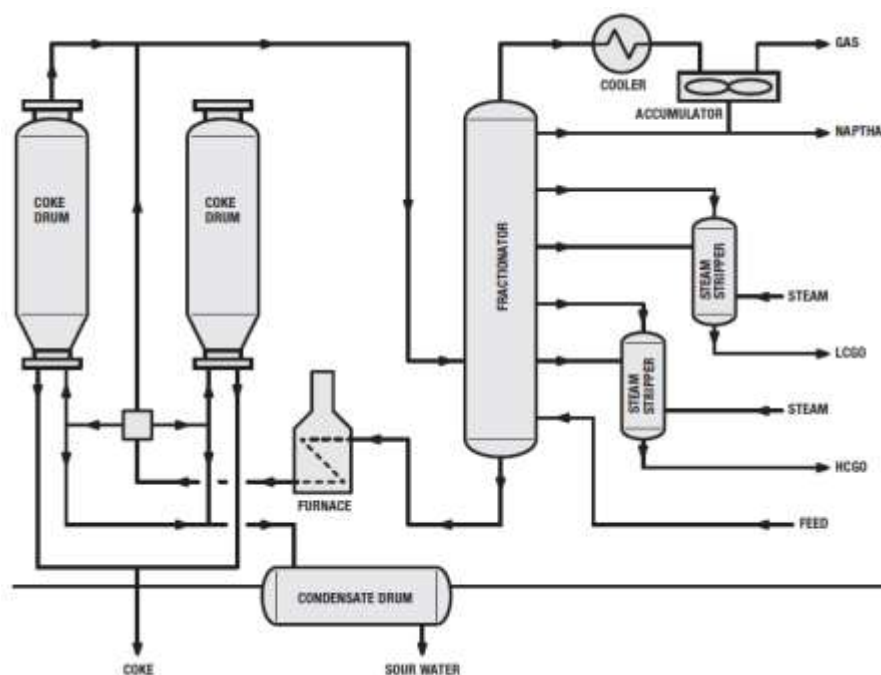
Coking was first introduced to commercial upgrading of bitumen when the Great Canadian Oil Sands (GCOS now Suncor) started up delayed coking in 1968. The next commercial application of coking in oil sands bitumen upgrading was by Syncrude when they started up Fluid Cokers in 1978. Coking technologies are central primary upgrading units in full upgrading facilities that produce bottomless SCOs. In most full upgrading plants, the blendstocks in SCO have been hydrotreated to stabilize and remove all olefins and much of the sulfur and nitrogen. Some producers sell a sour SCO, which blends unhydrotreated heavy coker products with hydrotreated lighter products.



## Delayed Coking

Delayed Coking is a semi-batch process where a furnace heats the feed to the point of incipient coking. The heated material is transferred in the minimum possible time to the coke drum where the coking reaction completes and cracked vapors exit the top of the drum. Coke drums are operated in pairs where one drum is filling with coke while the other is being decoked and prepared to accept feed. Cycles vary from 12-20 hours depending on the feed rate and size of the drums. A schematic of delayed coking is shown in Figure 5.4.

Figure 5.4: Delayed Coking Schematic



(MOGAS-2, 2017)

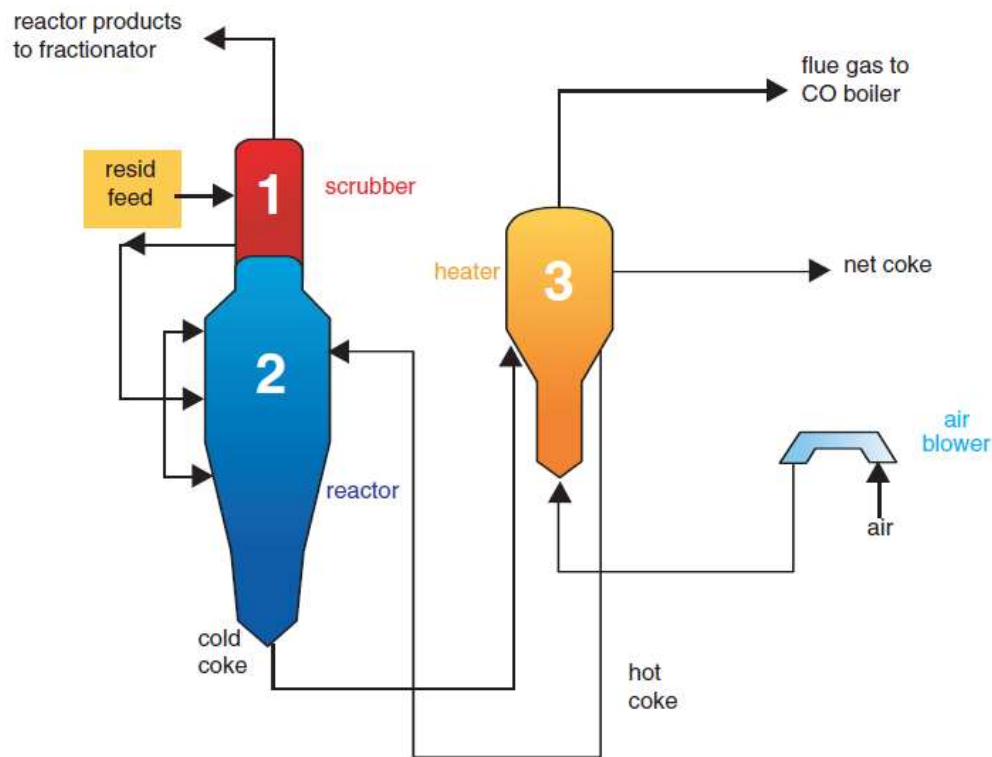
The delayed coking process produces a product that exceeds the required specifications for pipeline transportation, therefore, its normal operation does not fit the definition of partial upgrading as used in this study.

## FLUID COKING™

FLUID COKING is licensed by ExxonMobil and used in the Syncrude Upgrader in Alberta. A simplified diagram is shown in Figure 5.5. Feed is typically a 1050°F/565°C-plus vacuum residue that enters the scrubber (1) for integrated, direct contact heat exchange with reactor overhead effluent vapors. The scrubber condenses higher boiling hydrocarbons in the reactor effluent

(typically > 975°F/ 525°C) and recycles this material together with fresh feed to the reactor. Light overhead vapors are sent to conventional fractionation and light ends recovery. In the reactor (2), feed is thermally cracked to a full range of lighter products and coke. Coke inventory is maintained by transferring bed coke from the reactor to the burner (3) via a coke transfer line. Depending upon the feed, 15-25% of the coke is burned with air to satisfy process heat requirements, eliminating the need for an external fuel supply. Hot coke from the burner is circulated back to the reactor through a coke transfer line and supplies the heat needed to maintain reactor temperature and sustain thermal cracking reactions. The balance of coke is withdrawn and sold as a product. The coke burner also produces a low heating value flue gas that is usually sent to a CO boiler for further energy recovery through steam production.

**Figure 5.5: FLUID COKING**



(ExxonMobil, 2017)

**Support Units Required for Coking**

Coking requires the following support units in addition to utilities:

- Upstream crude and vacuum distillation
- Amine Plant
- Sulfur Recovery
- Sour water Plant

- Product hydrotreating (potentially mild in a partial upgrading application)
- Hydrogen production (to support hydrotreating)
- Offsites and storage

Coking units produce the following byproducts and waste streams:

- Sour fuel gas from which sulfur is recovered
- Coke
- Sour water

The normal commercial operation of fluid cokers is to recycle the unconverted vacuum residue until it is completely converted. This 100% conversion of the heavy material gives a liquid product that falls above the range of API gravity that defines partial upgrading. The commercial fluid coking process can be operated in a once-through mode, without recycle of the vacuum residue. In this case, the result is a partially upgraded crude oil that is much closer to the definition of partial upgrading. Consequently, once-through coking constitutes an available commercial technology that fits the performance definition of partial upgrading, in combination with some hydrotreating to remove olefins as illustrated in Figure 4.8. Mild hydrotreating of naphtha through kerosene or light diesel would be sufficient to remove olefins.

## **5.2.2 Asphaltene Rejection**

### **5.2.2.1 Solvent Deasphalting**

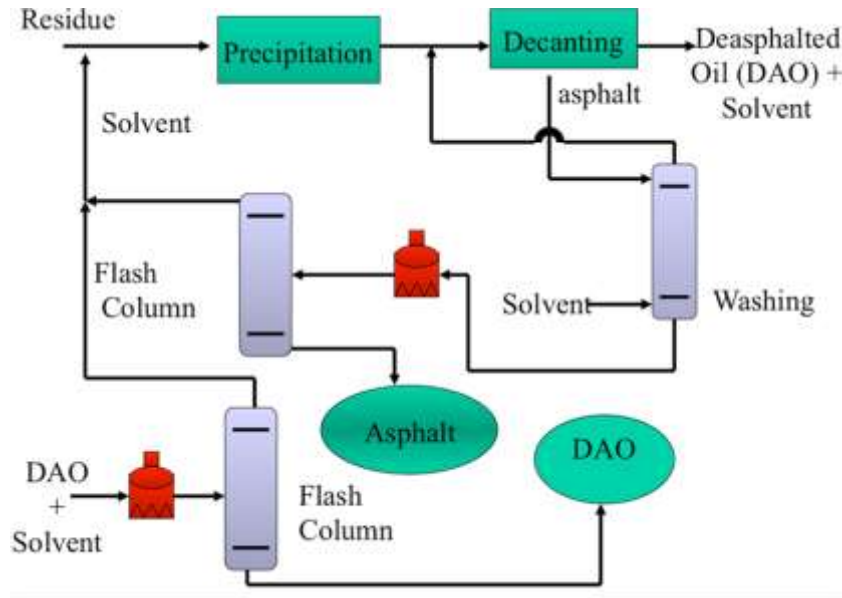
Solvent deasphalting (SDA) processes heavy gasoils and resids to produce a product low in asphaltenes and another high in asphaltenes. The SDA product that is low in asphaltenes has lower density, viscosity, metals and other contaminants than the feed. The product high in asphaltenes concentrates the impurities in the feed and can be used as fuel, or in production of road asphalt.

Solvents used in SDA include: propane, butane, pentane, and light naphtha. Solvent selection is based on the desired deasphalted oil purity and yield for a given feedstock. Higher molecular weight solvents provide higher yield of DAO, but with higher level of contaminants.

SDA together with delayed coking are commercially practiced asphaltene rejection technologies in heavy oil and bitumen upgrading and refining. SDA may be a better fit for partial upgrading because of its relatively low costs compared to coking. However, SDA achieves greater liquid product loss than coking (depending on solvent choice, ratio and design) as a result of some rejection of feed with the refractory carbon containing fraction (asphaltene product) – especially if the rejected carbon is a liquid pitch product. In addition, there is less conversion of refractory carbon in SDA than coking which operates at more severe conditions.

SDA uses an external circulated/recycled light hydrocarbon solvent that acts to separate asphaltenes and heavier portions of bitumen (maltenes and resins) which contains most of the metals and coke precursors in the bitumen from the gasoil and lighter portion. The SDA flow scheme is shown in Figure 5.6.

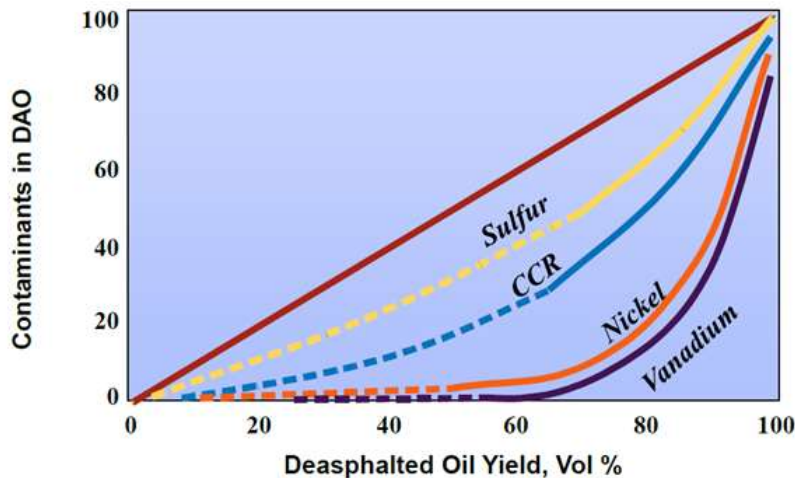
Figure 5.6: SDA Flow Schematic



(Gary, et al., 2007).

Figure 5.7 shows the tradeoff between yield of deasphalted oil (DAO) and rejection of contaminants. Lighter hydrocarbons go into the solvent, which is lighter than the heavy remaining fraction containing the asphaltene molecules. Choice of solvent affects the degree of hydrocarbon attraction and the quantity of DAO. As shown in Figure 5.7, as the yield of DAO increases, more contaminants remain in the DAO. Heavier solvents lead to less rejection of asphaltenes and higher yield of DAO, but with more contaminants.

Figure 5.7: Solvent Deasphalting Selectivity



(Beeston, S., 2014)

Solvent deasphalting by itself can only meet pipeline specifications with a very high fraction of the bitumen rejected, as in Figure 4.10, which is not economically feasible. SDA could be used for partial upgrading by coupling it with thermal cracking, however, the significant loss of volume with the rejected asphaltenes make the technology unattractive in comparison to newer deasphalting approaches discussed in Sections 5.4.2 and 5.4.3 below.

### 5.2.3 Fluid Mechanical

Fluid Mechanical upgrading technologies aim to reduce the viscosity of bitumen mixtures by breaking up the aggregated molecules in bitumen. Mechanical force is applied to bitumen as shear introduced via high pressure dispersal through nozzles, cavitation, or other means. The aim of mechanical upgrading is to change or modify the asphaltene microstructures in bitumen and heavy oils, which comprise the heaviest fraction and contribute to the high viscosities observed in these heavy oils. This mechanism is a matter of debate, as discussed in Section 4.8.3.2.

Energy used in mechanical upgrading is generally much lower than in other upgrading methods. Because there is usually no rejection of contaminants with mechanical upgrading and the conditions are mild, product yields are high. Some technologies may include adding heat to effect product upgrading, which brings the energy consumption closer to the thermal processes. However, product stability from modifying the asphaltene aggregates can be an issue which could lead to asphaltene precipitation over time and an unstable product.

### **5.3 Upgrading Technology Assessment**

New technologies for partial upgrading are at different stages of development. Some are still in laboratory evaluation others have been demonstrated in a continuous manner in small integrated units. We will begin with a discussion of technology readiness then briefly discuss many promising partial upgrading technologies and their level of readiness.

Technology readiness level (TRL) is a key finding from our work. We use the definition of TRL provided by Alberta Innovates. A key component of this assessment is early identification of issues (operational, availability, and constructability issues) coupled with technical, engineering, and economic assessment tailored to match the quality of the available data, which can be somewhat sketchy for new and novel technologies.

#### **5.3.1 Technology Readiness Levels**

The technology readiness levels defined by Alberta Innovates are shown in Table 5.1. In this report, we use available public information to place technologies in the stages: Research, Development, Pilot, Demonstration, and Commercial.

**Table 5.1: Technology Readiness Levels**

Development Stage	Achievement	Step
<b>Research:</b> Research is primarily done in the lab and ranges from fundamental curiosity driven research to proof of concept in a lab setting. Theory and scientific principles are focused on specific application area to define concept. Analytic tools are developed.	Basic principles of concept observed and reported	1
	Technology concept and/or application formulated	2
	Analytical and experimental critical function and/or characteristic proof of concept	3
<b>Development:</b> The basic technological components are integrated for testing in a simulated environment and includes alpha testing of options	Component and/or subsystem validation in a laboratory environment	4
<b>Pilot:</b> The prototype is tested in the field in an operational environment and is well integrated with other systems. 0.1-0.5% of commercial. Scale needs to be demonstrated.	Component and/or validation in a simulated environment	5
	System/subsystem model or prototype demonstration in a simulated end-to-end environment	6
<b>Demonstration:</b> The technology is being scaled up and tested in its final form and under expected conditions. Activities include the deployment of handbooks, documents, and maintenance. Typically, greater than 5% of commercial scale.	System prototyping demonstration in an operational environment	7
	Actual system completed and qualified through tests and demonstration in an operational environment	8
<b>Commercialization:</b> The first commercial application of the technology is established; the technology is ready for widespread adoption by others.	Actual system proven through successful deployment in operational setting	9
	Wide scale deployment	10

## 5.4 Overview of Potential New Upgrading Technologies

In this section we discuss a number of technologies that could be used to partially upgrade bitumen, giving improved quality and/or eliminating or reducing diluent for pipeline transport. The list of technologies is not based on a comprehensive search of patents and publications; rather it is a collection of processes that have been proposed by technology developers to the Alberta oil sands industry for implementation. This information is from public documents, and statements by developers. We have not substantiated the claims.

In addition to assigning a technology readiness level to each technology, and classifying it according to the main underlying fundamental steps, we comment on the other attributes of each process as follows:

- a) **Fit to Partial Upgrading of Bitumen (PUB)** – Does the product from the technology meet the definition of partial upgrading, or does it exceed the definition? (Does not meet, Meets, Exceeds, or Unknown)

- b) **Olefin Treating** – Is treatment of produced olefins required in order to meet pipeline specifications? (YES or NO)
- c) **Technical Basis** – Are the underlying engineering principles fully established, based at least on results from pilot testing? (YES, NO, or Unknown)
  - High – Established products with defined markets. This designation applies to well established technologies such as coking, hydroconversion and Fischer-Tropsch
  - Med – The products have attributes in common with heavy crudes and coker products, but are not identical and not on the market yet
  - Unknown – Very different products to established markets or ill-defined early-stage processes
  - Asphaltenes (+A) – The technology produces significant amounts of asphaltenes or similar byproducts for which no market has been defined yet and which may require disposal
- e) **Environmental Basis** – GHG Emissions – How do the GHG emissions compare to established technologies?
  - Baseline or near-baseline – similar to delayed coking
  - Below baseline – Lower than delayed coking
  - Medium – higher than baseline due to significant hydrogen consumption or partial coke combustion
  - High – complete coke combustion, gasification, or significant combustion of unconverted vacuum residue
- f) **Potential location for the use of such a process**
  - SAGD Integrated – The partial upgrader is located at the SAGD site and integrated with water treatment and steam generation
  - Bolt-on – Add on to a SAGD central processing facility
  - Central PUF – A centrally sited Partial Upgrading Facility (PUF) collecting product from multiple SAGD fields

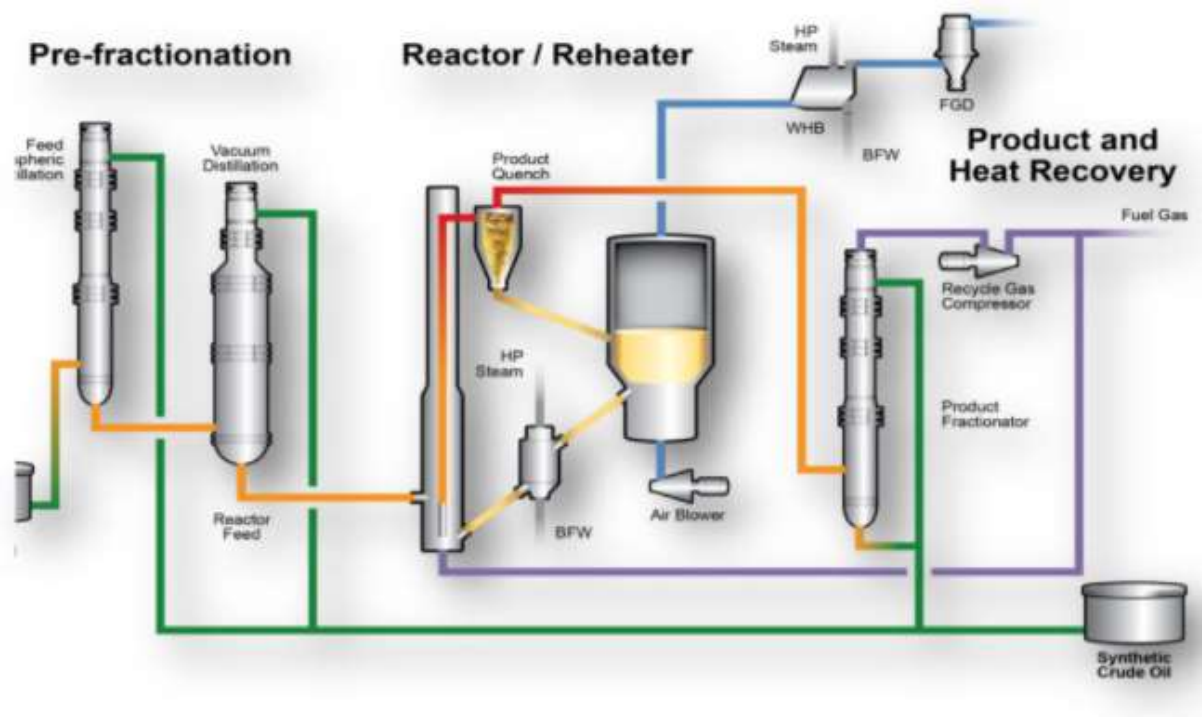


## 5.4.1 Thermal Cracking and Coking

### 5.4.1.1 Fluid Oil Viscositor

FluidOil has obtained the Heavy-to-Light (HTL) process from Ivanhoe. The basis for the HTL process is rapid, high temperature pyrolysis thermal cracking and coking of the feed using reactor technology similar to an FCC process, but without catalyst. The technology is now called Viscositor Heavy to Light (VHTL) and incorporating some additional technology. In VHTL, the coking reactions take place in a fluidized bed and then coke is burned off in a second bed to provide process heat. The difference with the FCC process is that VHTL uses circulating sand as the heating medium instead of FCC catalyst. A flow diagram for the process is in Figure 5.8.

Figure 5.8: HTL Process Flow Schematic



(Fluid Oil Corp., 2017)

The VHTL process was originally designed to be used at a heavy oil production site where waste heat recovered from burning coke would be used to reduce natural gas requirements for steam production for oil recovery. Because the HTL process burns coke and generates excess energy, this process has a high GHG footprint. In addition, because the process relies on thermal cracking, the product is olefinic and requires treatment to eliminate olefins. Fluid Oil claims that the VHTL product meets pipeline density and viscosity specifications and there

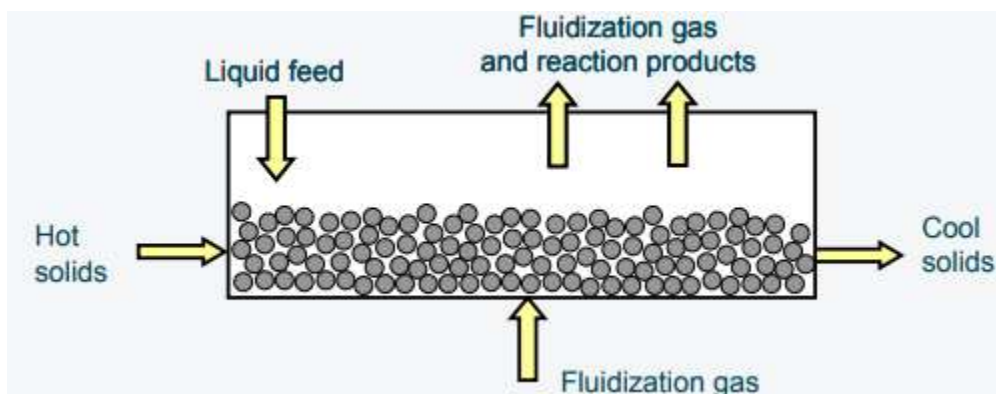
is no need to use diluent for pipeline transport. Fluid Oil claims that the technology was studied extensively during early pilot plant work and then validated by successful operation of a 1,000 bpd commercial demonstration facility in Bakersfield, California. Never-the-less, Fluid Oil's Viscositor technology's high GHG footprint makes it less attractive than other new technologies for partial upgrading of bitumen. Full conversion of vacuum residue would give a product that exceeds the range for partial upgrading.

(Fluid Oil Corp., 2017)

#### 5.4.1.2 ETX System IQ Technology

ETX has developed the IQ short residence time coking process which uses a cross-flow fluidized bed shown in schematic form in Figure 5.9. The principle of the IQ process is a cross-flow of solids and gas that ensures short residence time at temperature for the feed molecules and reduces over cracking and yield loss. The process uses a bed of solids that provides heat for reaction. This bed is horizontally transported while being fluidized by sweep gas that flows in the vertical direction. The rates of solid and gas flow can be adjusted for maximum liquid yield and minimum over-cracking, and also allow for operation at a lower reactor temperature. This combination is claimed to offer higher yields of liquid products than the Fluid Coking™ technology (Section 5.2.1.2).

Figure 5.9: ETX IQ Cross Flow Coking Process Schematic



(ETX Systems, 2017)

In the IQ process, a bed of inert solids or coke is vertically fluidized by recycle product gas and moves, via gravity, in a horizontal direction from left to right in the schematic shown in Figure 5.9. Liquid feed oil is sprayed onto the hot solids as they enter the reactor on the left in Figure 5.9. Cracking takes place on the hot solids. Volatile components in the oil are vaporized as a result of contact with the hot solids. Coking reactions take place in the remaining liquid. All volatile materials are swept from the reaction chamber with fluidization

gas. Any coke formed as a reaction product is transported to the right in Figure 5.9 together with the moving bed of solids.

Solid fines are removed from the reactor vapor via cyclones; condensable liquids are recovered. Solids exiting the reactor on the right in Figure 5.9 are routed to a fluidized-bed boiler to burn off coke and generate steam and also to reheat the solids before they are recycled back to the reactor.

ETX claims that the IYQ process offers significant advantage over fluid coking and other competing coking processes. ETX claims between 66-90 wt% yield of liquid product depending on reactor temperature and whether the unconverted vacuum residue is recycled to the reactor to be fully converted. The corresponding volumetric yields are claimed to range from 77% to over 90%, based on pilot-plant data.

The IYQ process produces a product that is similar to other coking processes, depending on the extent of recycle of vacuum residue. Operating on a single pass mode, the product would likely require a small amount of diluent to achieve the pipeline specifications (see Figure 4.8). With recycle of vacuum residue, the product would exceed the partial upgrading definition of this whitepaper, similar to delayed coking. A portion of the coke must be burned to maintain a heat balance, which leads to a medium increase in GHG emissions above baseline.

(ETX Systems, 2017), Brown, W. (2009). (Castaneda, et al., 2014).

#### **5.4.1.3 Husky Diluent Reduction (HDR™) Technology**

Husky claims that their Husky Diluent Reduction (HDR™) technology has the potential to reduce condensate diluent requirements by 50 per cent or more. The process relies on hydrogen donation from tetralin-like molecules in SCO to quench free radicals formed during thermal cracking of bitumen. As a result of hydrogen present during thermal cracking, deeper conversion can be achieved than in typical thermal cracking. Husky claims the HDR™ process can achieve 20+% conversion vs. <10% in conventional visbreaking to vacuum residue.

In the HDR™ process, bitumen undergoes specific heating, soaking, cracking, quenching conditions similar to thermal cracking (Figure 5.2). Husky claims the HDR™ process maximizes TAN reduction and minimizes coke make while converting residue to lighter fractions and leaving MCR unchanged. Thermal conversion of TAN is consistent with published studies and patents for TAN reduction. Included in the HDR™ process is a hydrotreating step to eliminate olefins.

According to Husky, the HDR™ process has undergone evaluation in the CANMET 0.5 BPD pilot test facility. Development has focused on identifying the optimum range of operating conditions. Husky claims that the HDR™ process results in no coke formation and the product meets pipeline viscosity specifications. However, the severity/conversion in the HDR™ process is limited by product stability as there is no asphaltene rejection step. According to Husky, blended product volume increased 1-2% over feed. Husky claims their HDR™ product met TAN specifications as a result of thermal conversion of naphthenic acids.

The product from HDR™ is claimed to meet the specifications for pipelining, therefore, this is a partial upgrading technology. The product would not be identical to medium crude oils due to its thermal history, but the significance of this difference to the refinery market is not well defined. Greenhouse gas emissions would be below baseline, similar to visbreaking.

(Husky, 2017)

#### **5.4.1.4 UMATAC Industrial Processes' Alberta Taciuk Retort Process (ATP)**

The Alberta Taciuk Process (ATP) is a horizontal rotating kiln retort originally designed in the 1980s to extract cracked bitumen products from mined oil sands. ATP is offered by UMATAC Industrial Processes, part of Thyssenkrupp and is operating in Fushun, China for shale oil production. ATP is claimed to process oil sands mined bitumen in capacities up to 800 MT/hr. of mined bitumen, equivalent to 10,000 BPD per unit. This process claims to handle ores that are oil or water wet and high or low grade.

This technology is applicable only to mined bitumen, and exceeds the requirements for partially upgraded bitumen. It is not suitable for SAGD operations. GHG production is high due to significant combustion of coke by-product.

(ThyssenKrupp UMATAC Taciuk, 2016)

#### **5.4.1.5 Water-Based Catalytic Visbreaking (Aquaconversion)**

Aquaconversion is a residue upgrading technology developed by PDVSA-Intevap in Venezuela. It is a form of visbreaking that incorporates catalytic steam conversion that claims to transfer hydrogen from water vapor into the unconverted bottoms of the crude, increasing its stability by avoiding the formation of more unstable asphaltenes.

Aquaconversion uses an oil soluble catalyst such as alkali metals salts based on potassium or sodium or metals in the crude oil. The catalyst is claimed to enhance dissociation of water to release hydrogen atoms, which are consumed in hydroprocessing. The oil soluble catalyst

and presence of water prevent coke formation and deposition of sediment that often occurs during visbreaking. It was developed in the 1990s and early 2000s but is no longer licensed.

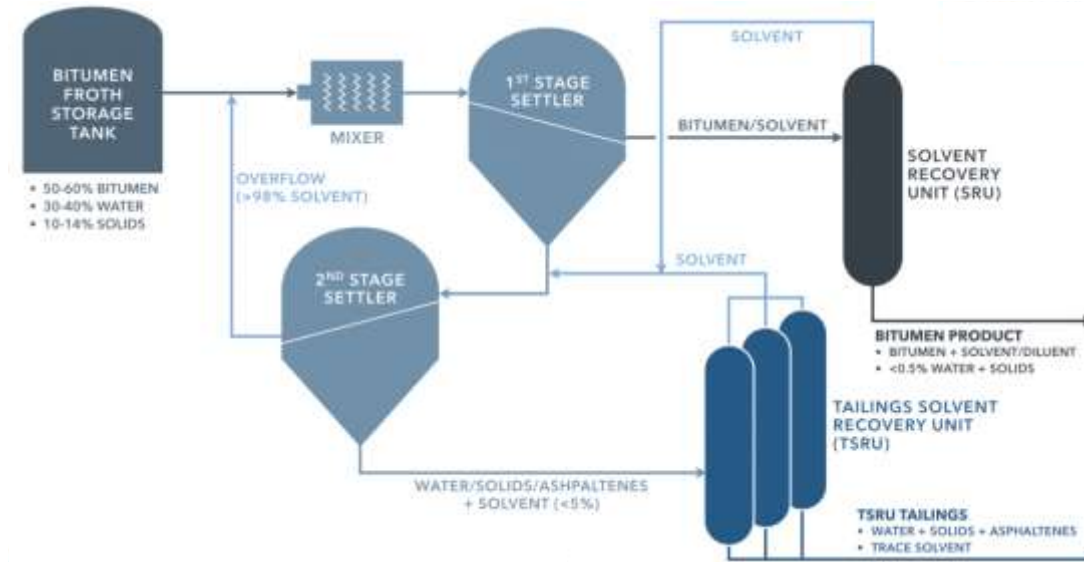
(Oil and Gas Journal, 2001)

## 5.4.2 Asphaltene Rejection

### 5.4.2.1 Commercial Paraffin Froth Treatment Process Block

Paraffin froth treatment (PFT) is a commercial technology used to process bitumen from mining, for example at Muskeg River, Jackpine, Kearn and Fort Hills. PFT typically rejects 10% of the bitumen, which reduces the concentration of asphaltenes and improves the bitumen properties, primarily by lowering the MCR. The major attraction of the technology is that it allows the diluted bitumen to meet the specification for bottoms sediment and water (BS&W) content. The treated bitumen also requires less diluent for pipeline transport. A simplified flow diagram is in Figure 5.10. The PFT process rejects significantly less material than conventional solvent deasphalting because the asphaltenes are solids, and are pumped as a slurry in water.

Figure 5.10 Paraffin Froth Treatment



(Oil Sands Magazine, 2017)

In a study for the Alberta Department of Energy (JacobsConsultancy, 2012), the API gravity of PFT treated bitumen increased from around 8.5 to 9.5 °API and the MCR decreased from roughly 13 wt% to 9 wt% as a result of PFT. Additional energy was required to recover the

solvent from paraffin froth treatment and there is a loss of roughly 8 vol% of bitumen, which is primarily asphaltenes sent to disposal (JacobsConsultancy, 2012). The energy consumption for mined bitumen processed by paraffin froth treatment is slightly higher than bitumen processed by naphtha froth treatment. However, there are energy savings in the overall well-to-wheels lifecycle GHG pathway because the bitumen can be refined directly and because this bitumen is of higher quality than bitumen from naphtha froth treatment. The well-to-wheels GHG intensity of gasoline and diesel from mined bitumen produced via PFT and then refined is around 2% lower than gasoline and diesel from mined bitumen produced via naphtha froth treatment, upgraded to SCO, and then refined.

PFT by itself is not sufficient by itself to achieve the pipeline specifications for viscosity and density, and would need to be coupled with other processes to significantly reduce the requirement for diluent. The capability of rejecting a portion of the asphaltene content, as practiced in PFT, is a powerful tool in partial upgrading, and it features in several of the combination technologies discussed in Section 5.4.3.

(Oil Sands Magazine, 2017), (Gray, 2015)

#### **5.4.2.2 Selex-Asp for Rejection of Solid Asphaltene**

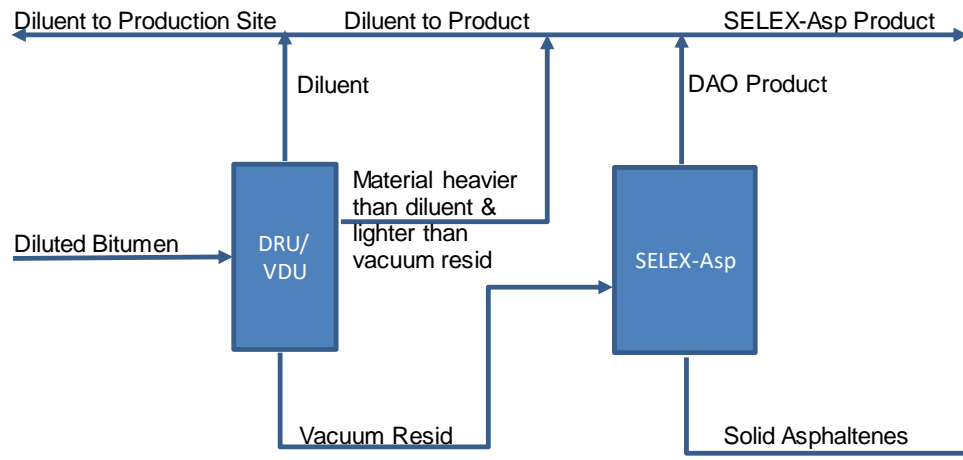
SELEX-Asp, developed by Well Resources, is a solvent extraction technology that uses paraffinic solvents to separate asphaltenes, and in some variants resins, from other components in crude oil. Unlike other commercialized solvent extraction processes (e.g. the KBR Rose and UOP-Foster Wheeler SDA processes), SELEX-Asp produces dry granulates of asphaltenes.

The asphaltene rejected from Athabasca bitumen contains about 88% C<sub>5</sub> insoluble asphaltenes, which means that as much as 20% of the bitumen could be rejected in the SELEX-Asp process. This yield loss is intermediate between solvent deasphalting (Section 5.2.2.1) and PFT. The relatively high rejection of bitumen as an asphaltene byproduct requires a market for this byproduct. In locations such as China, where there is a strong market for asphaltenes in non-fuel use as an asphalt blending stock, the economic incentives for SELEX-Asp are stronger than in a market like Alberta, which at this time has a limited market for rejected asphaltenes. Currently, Well Resources reports that four plants utilizing the SELEX-Asp technology are operating in China with capacities between 500 bpd and 20,000 bpd (Roche, Feb 5, 2018). Well Resources is investigating other uses for rejected asphaltenes.

According to Well Resources, the SELEX-Asp process can improve the API gravity of a 7.8 API bitumen to 13 API by rejecting 16 wt% of the bitumen as an asphaltene byproduct (Chung, et al., 2006 Q4). The net result of processing bitumen in SELEX-Asp is that the volume of

diluent needed to transport bitumen in a diluent-bitumen mixture meeting the pipeline minimum of 19 API decreases from 30 vol% for raw bitumen to around 18 vol% for the upgraded bitumen product from SELEX-Asp. A schematic for processing bitumen in SELEX-Asp is in Figure 5.11.

**Figure 5.11: Well Resources SELEX-Asp Process**



To further reduce diluent usage, the SELEX-Asp process must be coupled with a conversion process, such as thermal cracking, coking, or resid hydrocracking.

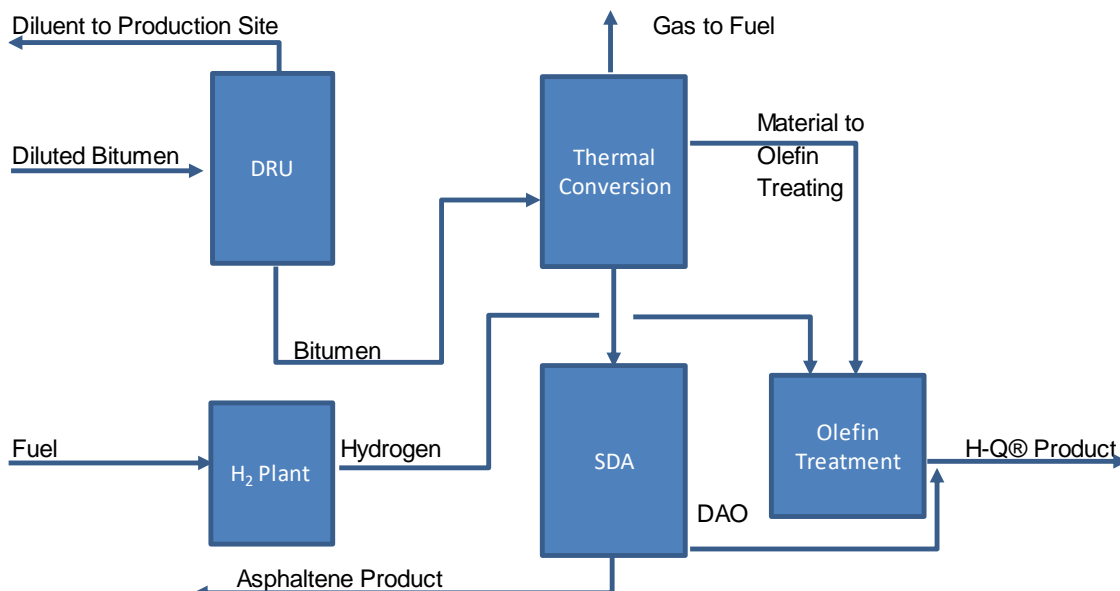
(Yuan, 2016), (Xu, et al., 1998; Well Resources, 2018).

### 5.4.3 Combined Thermal Cracking and Deasphalting

#### 5.4.3.1 MEG HI-Q® Partial Upgrading Technology

MEG Energy has developed the HI-Q® bitumen partial upgrading process that yields a product that meets pipeline transportation specifications without needing to add diluent. The technology is based on modified mild thermal conversion to yield a totally distillable overhead product and a heavy bottoms product that is further upgraded by novel solvent de-asphalting to yield near asphaltene-free oil (DAO). Solvent deasphalting and thermal cracking are well proven technologies. The process schematic is shown in Figure 5.12.

Figure 5.12: MEG HI-Q® Bitumen Partial Upgrading Process



MEG claims that HI-Q® is a low-intensity, low-complexity bitumen upgrading process that combines mild, thermal cracking with solvent deasphalting. In the HI-Q® process, dilbit is delivered to the upgrading facility via pipeline. Diluent is first separated in the DRU and returned to the in situ bitumen production site. The stripped bitumen from the DRU is fed to the first step in the HI-Q® process which is the mild thermal cracker. Light material is evolved and removed from the thermal conversion step. An olefin treatment step on the thermally converted lighter hydrocarbons is needed to meet pipeline specifications. Heavy liquid material remaining after the thermal cracking step is sent for solvent deasphalting. Asphaltenes are precipitated and removed as a clean solid product from the SDA. The remaining deasphalted oil (DAO) is mixed with the light material from the thermal conversion step to produce the HI-Q® product, a sour synthetic crude oil that meets transportation specifications and has added market value compared to the diluted bitumen.

MEG has demonstrated the HI-Q® process in a 10 BPD continuous demonstration plant at Western Research Institute in Laramie, WY.

MEG claims high yield ~ 90 vol% yield of liquid product from Athabasca bitumen (higher yields on Cold Lake bitumen) with lower MCR than in the bitumen feed, which means less coke production in a refinery. In addition, MEG reports the product contains less TAN, which means less corrosion and reduced metals content, and contains little or no asphaltenes. This process returns all of the transport diluent to the production site and delivers an upgraded bitumen crude that meets pipeline specifications.



MEG reports that the HI-Q<sup>®</sup> vacuum residue fraction is reduced from 56% in the feed bitumen to 18% of the product. Naphtha production is minimized and represents about 8% of the product. The largest portion of the HI-Q<sup>®</sup> product is kerosene, diesel and gasoils. A comparison of the feed bitumen properties with HI-Q<sup>®</sup> product properties provided by MEG is shown in Table 5.2.

**Table 5-2: Properties – Bitumen vs. HI-Q<sup>®</sup> Product**

Property		Bitumen	HI-Q <sup>®</sup> Product
API Gravity		8	20.1
Viscosity	cSt	166,000,000	58.5
MCR	wt%	15.5	2.7
TAN	Mg KOH/g	2.5	0.3
Nickel	ppm	104	5.54
Vanadium	ppm	279	10

MEG claims that the HI-Q<sup>®</sup> process offers the potential to upgrade bitumen sufficiently to meet pipeline specifications in a process that is simpler than full upgrading using delayed coking with higher liquid yields. The bitumen product would be similar to medium crude oils but with some differences in the vacuum residue due to the thermal cracking history. Greenhouse gas emissions would be below baseline. The location could be at a SAGD site or a centralized facility.

(MEG-1, 2017)

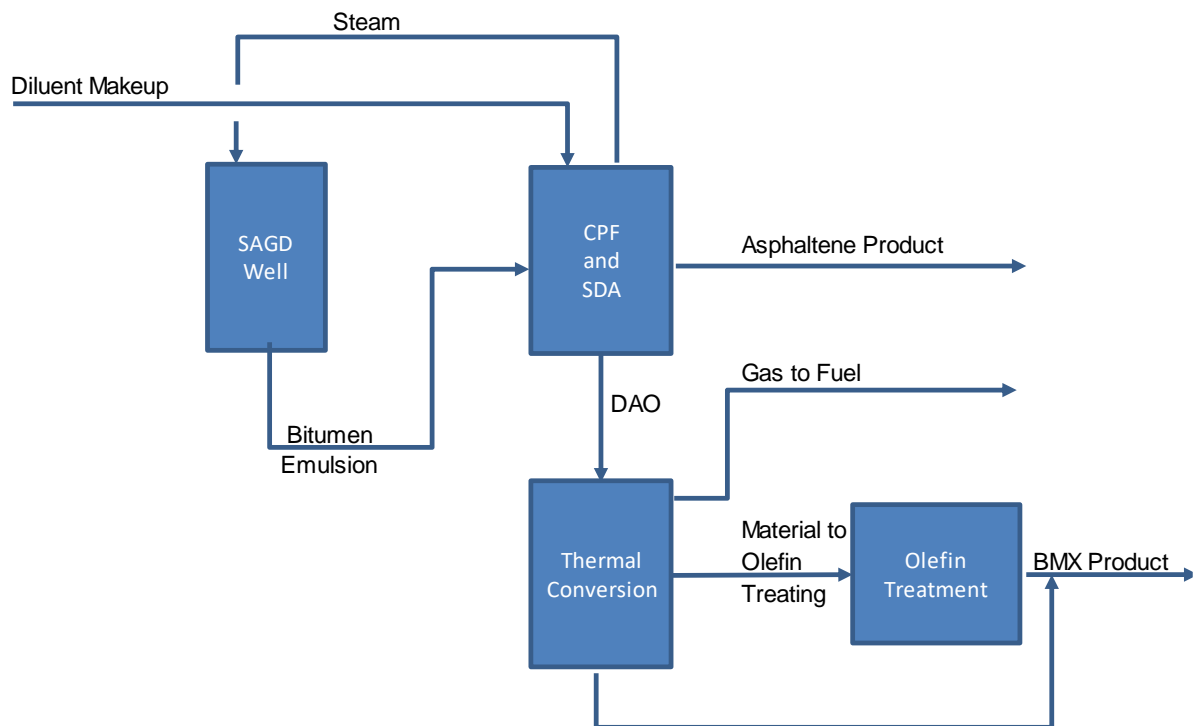
#### **5.4.3.2 Nexen BituMax<sup>™</sup> Partial Upgrading Technology**

Nexen Energy ULC has developed the BituMax<sup>™</sup> process to partially upgrade bitumen sufficiently to reduce or eliminate the need for diluent. The process combines solvent deasphalting and thermal cracking to produce an upgraded oil called BMX and a solid asphaltene product. The order of thermal cracking and solvent deasphalting is reversed from the line up used in the HI-Q<sup>®</sup> process (Figure 5.15).

The BituMax™ process is close coupled with the SAGD process for in situ production of bitumen. Feed to the process is a water-oil emulsion from SAGD. Water is recovered in the BituMax™ solvent deasphalting process and returned to the SAGD process. The BituMax™ SDA processing step recovers three phases: water, asphaltene pitch, and DAO. Nexen claims there is equipment savings compared to separate stand-alone SAGD and partial upgrading facilities. Because this process uses thermal cracking to improve yield, it produces olefins that must be removed in an olefin treating process. Nexen is progressing research on a new chemistry path (alkylation) for treating the olefins. If successful, this would represent an improvement in capital and operating costs and a reduction in GHG emissions over conventional hydroprocessing.

Figure 5.13 shows a schematic of the BituMax™ flow diagram. In this process, solvent deasphalting is completed before thermal cracking. DAO from solvent deasphalting goes to thermal cracking. Products are fractionated and some of the bottoms may be recycled to thermal cracking. Nexen claims the configuration enables milder thermal cracking to better achieve the level of conversion desired and maintain product stability.

**Figure 5.13: Nexen BituMax™ Process Schematic**



Nexen has demonstrated the processing steps in the BituMax™ process at small pilot plant level. Solvent deasphalting of the bitumen-water mixture from in situ production has been demonstrated. Thermal deasphalting of DAO from the deasphalting process has been demonstrated. Olefin reduction via alkylation is undergoing demonstration at pilot-plant scale. A comparison of bitumen feed and BituMax™ product from Nexen is shown in Table 5.3.

**Table 5.3: Properties – Bitumen vs. BituMax™ Product**

Property	Units	Bitumen	BituMax™ Product
API Gravity		8.3	20.5
Viscosity @20°C	cSt	420,000	147
Sulphur	wt%	4.8	3.7
MCR	wt%	14.6	10.4
TAN	Mg KOH/g	2.2	1.6
Nickel	ppm	89	40
Vanadium	ppm	247	101

(Nexen, 2017)

The BituMax™ process offers the potential to upgrade bitumen sufficiently to meet pipeline specifications. Like the MEG HI-Q® process, the BituMax™ process is simpler than full upgrading using delayed coking and gives higher yields, but produces a product that needs to be explored for acceptance by petroleum refiners. The opportunity to fully integrate with SAGD operation offers opportunities for savings. GHG emissions would be below baseline.

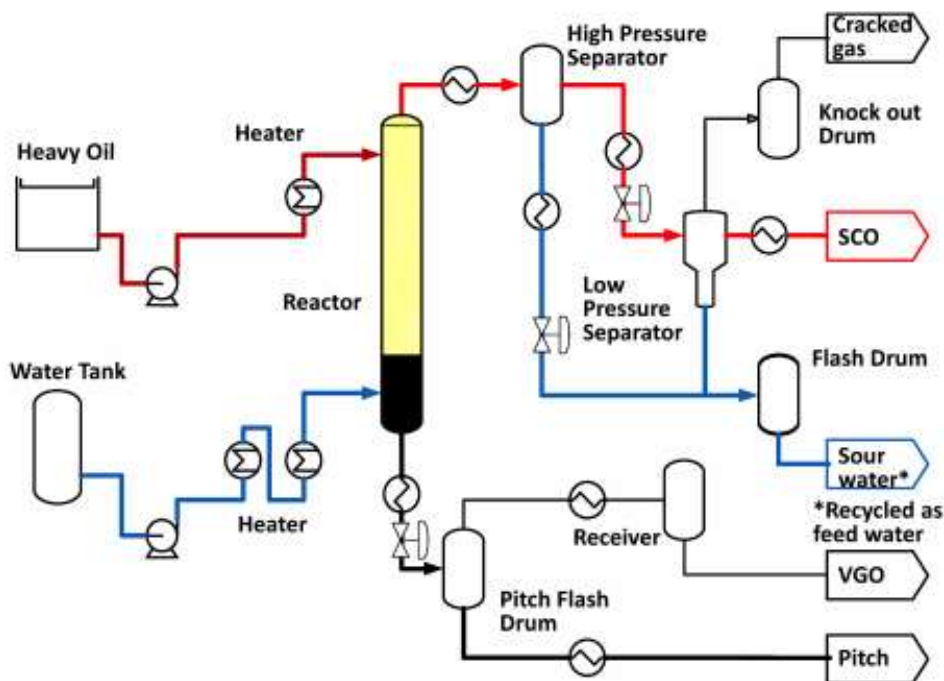
(Nexen, 2017)

#### **5.4.3.3 Water-Based Supercritical Solvent Extraction (JGC)**

In the JGC Supercritical Water Cracking process, undiluted bitumen from a SAGD process is heated to improve flow and contacted in a reactor with supercritical water in approximately 1:1 weight ratio. The operating conditions are 22-25 MPa (3,200-3,600 psi) and 395-430 °C (743-806 °F).

Supercritical water acts as a partially miscible solvent (similar to a traditional deasphalting process) to form two liquid phases in the reactor. The lighter, water rich phase containing the hydrocarbon product, leaves the top of the reactor where it is cooled and the water and hydrocarbon phases separate in a two stage high pressure/low pressure separation system. A flow diagram is shown in Figure 5.14.

Figure 5.14: JGC Supercritical Water Cracking Technology



(Kayukawa., et al., 2017)

The heavier, residue rich phase, leaves the bottom of the reactor where it is cooled and flashed to recover lighter hydrocarbon fractions, which can be blended with the overhead hydrocarbon stream. The flash conditions can be optimized to maximize product yield and minimize pitch yield. The pitch stream is a by-product that is a separate commercial product, most likely used as fuel. Water in the pilot plant is used once-through. In a commercial plant, the water will be cleaned and recycled.

This process has been demonstrated at 0.15 and 5 BPD pilot plants operating on Alberta bitumen.

The JGC Supercritical Water Cracking process is not applicable for partial upgrading because it involves expensive high-pressure processing of bitumen in large volumes of supercritical water, producing a large volume of heavy residue pitch product, which reduces the amount of material available for further upgrading, and results in high GHG emissions if used as fuel.

#### 5.4.3.4 VCI's ADC and COC Technologies

Value Creation (VCI) claims to have developed a partial upgrading process based on deasphalting followed by thermal cracking. VCI's solvent deasphalting process is called

accelerated decontamination (ADC™) and is based on the use of water as in paraffinic froth treatment used to process mined bitumen. (This is similar to the approach in Nexen's BituMax process.) The product from ADC™ is a decontaminated oil (DCO) product and an asphaltene pitch. The deasphalted oil is converted to lighter material in their Clean Oil Cracking (COC™) process. They claim an upgraded sour synthetic crude that requires no diluent but is olefinic. Asphaltene pitch goes to sales or storage.

This process appears to have similarities to Nexen BituMax™ in coupling solvent deasphalting and thermal cracking with a feed from SAGD wells, but insufficient information is unavailable to enable a more detailed comparison. The development of the processes appears to be in hiatus and it is not clear if they have been demonstrated. The VCI website has not been updated since June 2016.

(Value Creation, 2016)

#### **5.4.4 Hydrogen Addition and Cracking**

##### **5.4.4.1 Hydrovisbreaking**

The Hydrovisbreaking Process (HYCAR) is a non-catalytic process, based on visbreaking, that involves visbreaking followed by treatment with hydrogen at mild conditions to increase conversion, reduce impurities, and produce higher quality products than conventional visbreaking. Developed by Showa Shell in the 1980's, hydrovisbreaking requires three reactors: a visbreaking reactor for thermal cracking; a catalytic demetallization; and hydrocracking. The visbreaking reactor uses mild thermal conditions in the presence of hydrogen to crack molecules, the demetallization reactor catalytically removes contaminants, particularly metals, prior to the hydrocracking reactor. The hydrocracking reactor uses an inexpensive cobalt molybdenum catalyst to remove metals and crack complex molecules.

This technology has been around for more than twenty years. As far as we know, it is not licensed nor has any commercial process been built. It is more complicated than simple visbreaking and is considerably more complex and expensive than the lower capital partial upgrading technologies.

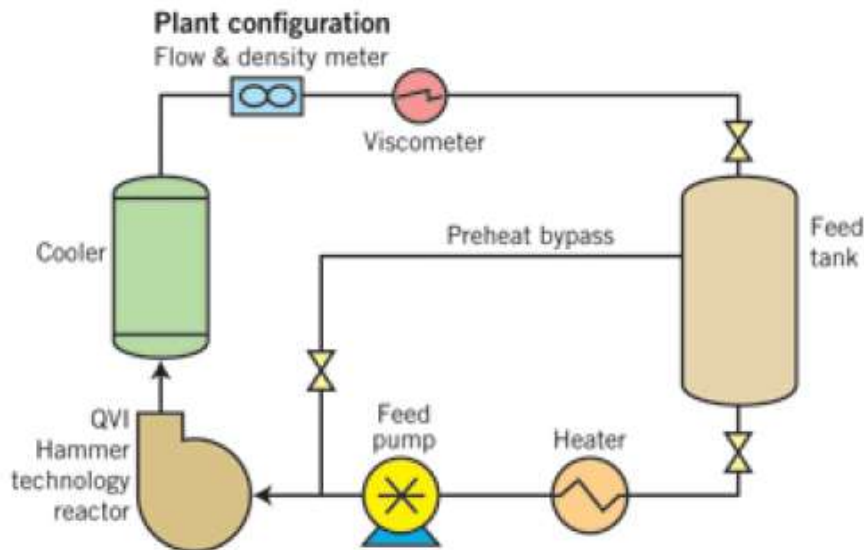
(Arahata, et al.).

## 5.4.5 Fluid Mechanical

### 5.4.5.1 Superior Upgrading Tech./Hammer Technology

Superior Upgrading Technologies has developed the Hammer Technology for upgrading bitumen. This technology relies on the combination of fluid hammer effect and hydrodynamic cavitation. Superior Upgrading Technologies claims that extreme shear can create sufficient high-velocity fluid kinetic energy to break bitumen's molecular hydrocarbon bonds at nearly ambient temperature and pressure (cold cracking) and meet pipeline specifications with little or no diluent. This technology does not reject contaminants. The block flow diagram shown in Figure 5.15 includes a heater

Figure 5.15: Superior Technology Hammer Technology



(CERI, 2015)

It is not clear from the process description whether this process is a kinetic process with thermal cracking or simply a kinetic upgrading process. Product stability is a key parameter in processes such as this.

The Hammer technology is still in the early stages of development.

(CERI, 2015)

#### **5.4.5.2 Electromechanical Based Technologies**

#### **5.4.5.3 Petrosonic**

Petrosonic has patented the Sonoprocess, which uses soundwaves to break down the viscosity of heavy crude. Very little can be found about this process or this company. The technology does not appear to have been demonstrated.

(Petrosonic Sonoro) – there is no Petrosonic website; Sonoro has exited this business

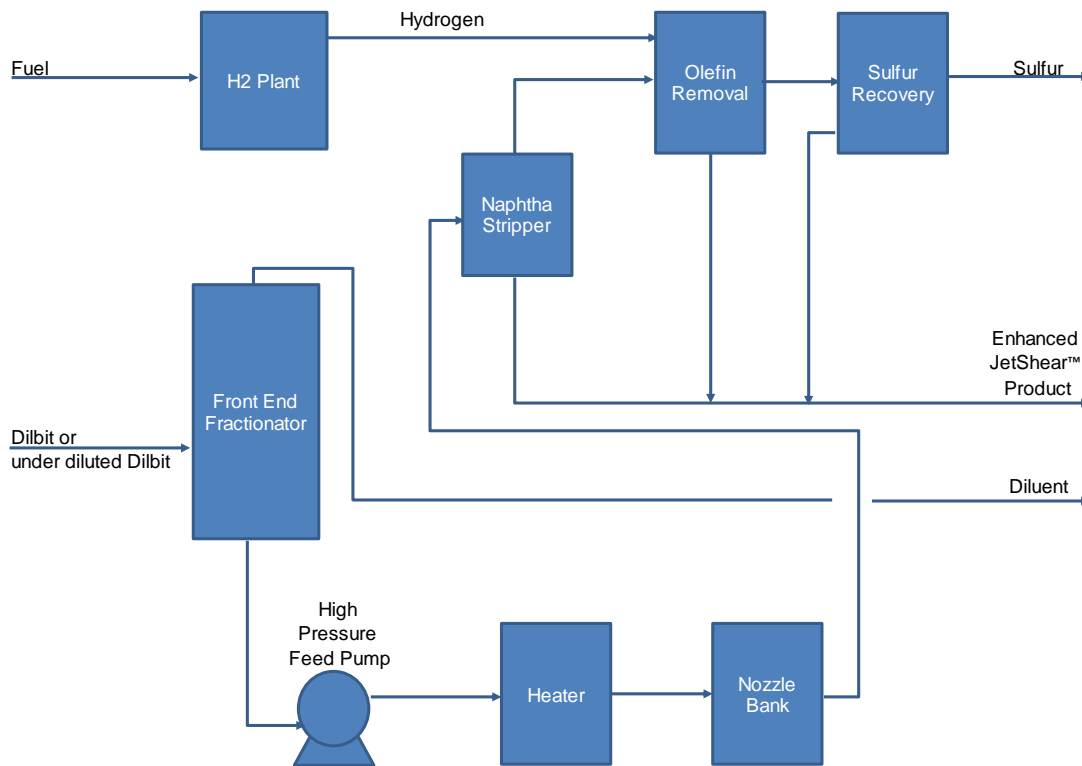
### **5.4.6 Fluid Mechanical and Thermal Cracking**

#### **5.4.6.1 Fractal Systems Jet Shear™/Enhanced Jet Shear™**

Fractal System's JetShear™ bitumen partial upgrading technology uses low severity, hydrodynamic cavitation and heat to structurally modify asphaltene molecules by separating resin groups attached to the asphaltene core. Fractal claims that JetShear™ causes a rapid change in pressure at temperatures below incipient cracking temperature which allow microbubbles to form around nucleation sites. Fractal claims that kinetic energy from cavitation, converts to chemical energy and modifies heavy oil microstructures and the state of aggregation of bitumen asphaltenes. Fractal claims that the resulting breakup of asphaltene structures reduces viscosity and bulk density with essentially no change in the chemical composition or volumetric yield. Fractal claims that the JetShear™ process improves viscosity and density as well as results in a modest reduction in TAN. With Enhanced JetShear™ further reductions in these properties are possible. Fractal combines fluid mechanical breakup of asphaltene aggregates with thermal cracking.

Figure 5.16 shows the process configuration for the Enhanced JetShear™ which adds a hydrotreating step to the JetShear™ process to meet the pipeline olefin specification.

Figure 5.16: Fractal Enhanced JetShear™



Source: Fractal 2016/2017

In a commercial configuration of the JetShear™ and Enhanced JetShear™ processes, a dilbit or heavy oil blend is delivered from the production facility or terminal. The first step is removal of light ends by fractionation. These light ends are not further processed and are separated and then blended, as required, into the final sales blend, recirculated back to the CPF or diverted to sales. Heavy oil from fractionation goes to the core JetShear™ module where it is heated to thermal cracking temperatures and pumped through proprietary jet-nozzles where cavitation occurs. The upgraded product is cooled and sent to the sales tank to be blended with enough light ends removed in the first processing step to become the partially upgraded bitumen product that meets pipeline specifications.

A comparison of product quality from JetShear™ and Enhanced JetShear™ from Fractal System's public representations of their processes is in Table 5.4. These data show diluent use is reduced from 32 vol% in the original dilbit to 20 vol% with JetShear™ and 18 vol% with Enhanced JetShear™.



**Table 5.4: Fractal Systems' Representation of JetShear™ and Enhanced JetShear™ Pipeline Spec Products**

Properties	Raw Bitumen	Dilbit	JetShear™	Enhanced JetShear™
Density (°API)	7.5	22	19	19
Viscosity (cSt) @ 12° C	200,000-1,500,000	≤350	≤325	≤250
Diluent content (%)	n/a	~32	~20	~18
Diluent displacement (%)	n/a	n/a	~42	~53
Olefin content (wt %)*	0	0	~1%	<0.5%
Acid Number (mg KOH/g)	2.25	1.68	1.25	0.6
Sulphur content (wt %)	4.75	~3.6	4.0	3.9

\*Detection limit is 0.5 wt% via NMR

According to Fractal, the JetShear™ process has been tested in a 1 to 30 BPD laboratory pilot facility prior to 2009. From 2009-2012 it was tested in a 300 BPD field test facility using two 150 bpd nozzles.

During 2013, Fractal entered into technology and testing agreements with a large Canadian oil sands producer and in April of 2014, the parties commenced testing diluted bitumen at Fractal's 1,000 barrel per day JetShear™ demonstration facility located near Provost, Alberta. The facility operated for approximately one year. During this period, the facility processed over 113,000 barrels of partially diluted bitumen that was trucked to the site.

The goal of the project was to (1) meet processing objectives with two 500 bpd commercial-size nozzles, (2) achieve desired nozzle life performance (> 6 months) (3) meet facility operability and throughput expectations with no safety or environmental incidents, and (4) to achieve certain product quality targets for product stability (P-value >1.5), TAN reduction (>15%), and liquid yield (~100 vol%). According to Fractal, all key targets were met or exceeded and the demonstration was deemed a success by the partnership.

Supported by the successful demonstration of the JetShear™ technology platform, Fractal commenced engineering for a retrofit and expansion of the existing facility to demonstrate the Enhanced JetShear™ and Acid Reduction Process™ (ARP™) platforms. Construction on the retrofit started in the first quarter of 2016, was commissioned through that summer and operated from late August 2016 through August 2017.

According to Fractal, during the operating period, the Facility processed over 113,000 barrels of partially-diluted bitumen that was trucked to the site from a SAGD project. The Facility achieved up to 53% diluent displacement and the TAN of the diluted bitumen was reduced by

at least 60% to well below a TAN level equal to 1 mg KOH/g. In addition, according to Fractal, this performance was achieved while maintaining olefinic content of the crude at or below the detection limit (1% by weight).

Because there are no asphaltenes removed in the JetShear™ process, product stability is a concern. However, Fractal Systems claims experience at the commercial demonstration facility have shown product stability not to be an issue, with P-values for Enhanced JetShear™ products meeting pipeline specifications falling in a range between 1.5 to 2.4, depending on the processing severity employed.

Fractal claims that the Enhanced JetShear™ process offers the potential to reduce diluent needs by 50 to 60% and upgrade bitumen sufficiently to meet pipeline specifications in a process that is simpler than visbreaking (Section 5.2.1.1). Like the other thermally altered bitumens, the product has attributes in common with heavy crudes and coker products, but it is not identical and not on the market yet. The market value of these partially upgraded products depends on results from refinery processing. GHG emissions would be below baseline.

(Fractal Systems, 2016-2017), (Chornet, et al., 2008).

## 5.4.7 Other technologies

### 5.4.7.1 Field Upgrading - Molten Sodium Upgrading

Field Upgrading uses molten sodium to remove sulfur and upgrade bitumen. They use an advanced ceramic membrane in an electrochemical process to recover sodium. The process is called the De-Sulphurization & Upgrading (DSU™) process.

The DSU™ process mixes elemental molten sodium and hydrogen with a sour heavy oil feedstock. The DSU™ product is a low sulfur upgraded heavy oil product that is 8-10 API higher than the feed. According to Field Upgrading, the level of API increase depends on the amount of sulfur in the feed. In addition, the DSU™ product contains no sulfur, no heavy metals, no TAN and is greatly reduced in asphaltene content.

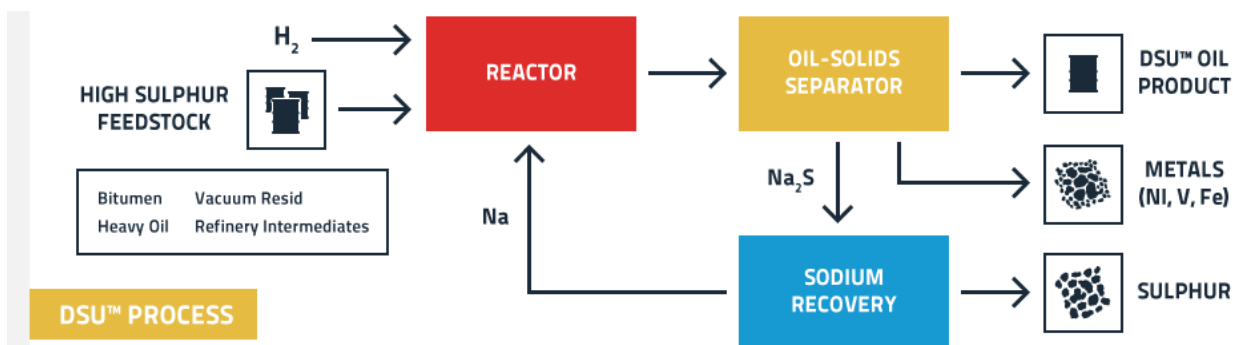
The key to DSU™ is sodium, a potent reducing agent with a strong affinity for heteroatoms and metals interspersed in the complex hydrocarbon molecule. There are three steps in the process:

- 1) Removal of metals, sulfur and nitrogen from bitumen by reaction with sodium.
- 2) Radical capping of upgraded molecules using hydrogen to prevent formation of cyclic hydrocarbons and olefins.

- 3) Recovery of sodium using a patented ceramic transport membrane reactor developed by Ceramatec. When electricity is applied to the ceramic membrane, elemental sodium is extracted ionically through the membrane and recycled to the process. Sulfur and metals are the other products.

A schematic of the process is in Figure 5.17

**Figure 5.17: Field Upgrading DSU Process**



(Field Upgrading, 2017)

The DSU™ process does increase the gravity of the product and reduces viscosity as a consequence of sulfur removal. However, such a low-sulfur product is not valued by the US refineries which already have sulfur removal capacity. Rather than partial upgrading, this technology is a likely to be a better fit in low-sulfur fuel markets.

#### 5.4.7.2 Novel Additive-Based Upgrading

Bayshore Petroleum has developed a Cold Catalytic Cracking (CCC) upgrading technology for partial upgrading of bitumen (to lighter oil), and full upgrading (to diesel fuel). According to Bayshore, Cold Catalytic Cracking achieves upgrading without hydrogen, pressure vessels, and uses less heat and energy than other partially upgrading processes. According to Bayshore, CCC has a smaller greenhouse gas footprint than conventional upgrading processes.

The physical and chemical principles of this process are unpublished, and no patents appear to have been awarded in Canada or the United States. In addition, it is still at lab scale.

(Bayshore Petroleum, 2015)

#### **5.4.7.3 Novel Diluent**

Use of light paraffinic condensate as diluent instead of the current heavier diluent has been proposed. A lighter diluent will reduce dilbit viscosity with less volume than the current heavier condensate. The objective is to use less diluent than is currently being used. However, diluent cost will be higher because the diluent is a specialty product. Novel diluent is out of scope for this technology evaluation.

#### **5.4.7.4 Bitumen Solidification**

The University of Calgary is investigating encapsulating bitumen with a solid coating made from bitumen to produce a solid brick that can be shipped like coal.

This technology is still at the development stage. It is out of scope because it does not address partial upgrading criteria.

#### **5.4.7.5 Auterra Oxidative Desulfurization the FlexUP™ Process**

Oxidative desulfurization converts sulfur in oils to sulfites, sulfates, sodium naphthenates, and sulfones. The process is claimed to increase oil API gravity. Lab results on heavy oils are lacking and this process has not been piloted. Patents only describe conversion of sulfones from very simple diesel-range model compounds. To our knowledge, no oxidative desulfurization on any feedstock is operating or has operated commercially. According to Auterra, FlexUP™ is a “catalytic process that offers the disruptive ability to upgrade heavy-sour crude oil, providing an increase in value as high as 5% -20%. Because FlexUP™ has a small physical and carbon foot print; oil producers can field upgrade heavy-sour oil while drastically improving their economics. FlexUP™ has been successfully tested on many heavy-sour crude oils as well as bitumen and asphaltene feeds.” One of their patents claims oxidative desulfurization using a titanium (IV) catalyst and organo-hydroperoxides.

This technology is still at the development stage and has not been piloted.

(Auterra, 2017)

#### **5.4.7.6 In Situ Upgrading**

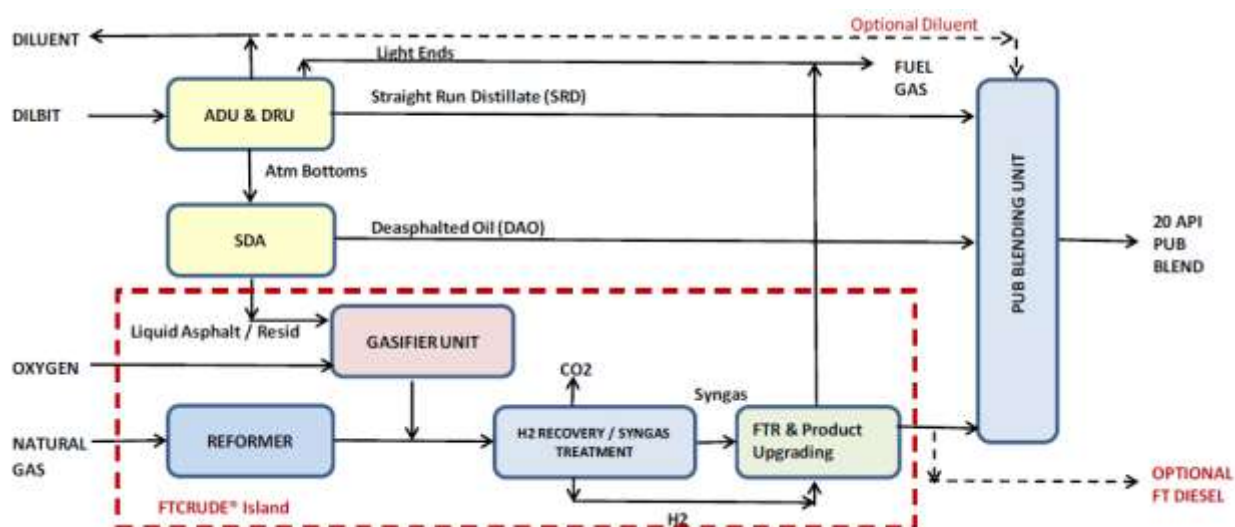
The University of Calgary is researching at lab scale, injection of catalysts into an in situ bitumen production well to upgrade bitumen to meet pipeline specifications. Asphaltene coke products from reaction are left in the reservoir. This concept is still at lab scale.

(Hashemi, 2013)

### 5.4.7.7 Expander Energy FTCrude®

Expander Energy offers the FTCrude® bitumen upgrading process that uses a novel arrangement of existing commercialized/licensed technologies, mainly based on the well-established Fisher-Tropsch technology. In this process, dilbit is first fractionated in a distillate recovery unit (DRU) which also removes gas oils. The atmospheric residue from the DRU is deasphalted in an SDA unit. The pitch from this process, containing the asphaltenes, is gasified to generate clean syngas, primarily consisting of H<sub>2</sub> and CO. Gasifier syngas is enhanced with hydrogen-rich reformer syngas from steam methane reforming of natural gas to provide a stoichiometric feed for FT synthesis, which produces a synthetic fuel product that is primarily high-cetane diesel. Light material removed from the DRU is blended with deasphalted oil, and the FT product to make a partially upgraded bitumen product that meets pipeline specifications without needing to blend diluent. The volumetric yield of upgraded bitumen is in excess of 110% of bitumen feed as a result of the natural gas used in addition to bitumen. A schematic of the process is given in Figure 5.1.

Figure 5.18: Process Schematic Expander Energy offers the FTCrude®



The FTCrude® process has not been demonstrated in lab or pilot scale. However, all the individual technologies have been demonstrated. This technology would give a high-quality product well outside the range defined for partial upgrading. This process would not likely be viable in the oil sands industry even for full upgrading for SCO production given its the high capital cost for the multiple processes illustrated in Figure 5.1. GHG emissions from gasification are high, unless carbon capture and sequestration are added to the process.

(Expander Energy, 2017)

## 5.5 Partial Upgrading Technology Comparisons

The upgrading technologies discussed in this section have been put on similar basis for comparison in Table 5.5. The descriptors use for each technology in the columns of Table 5.5 were introduced in Section 5.4 on Page 86. They are as follows:

- a) **Technology Status** – Stages are Commercial, Demonstration, Pilot, Development, and Research, as listed in Table 5.1.
- b) **Fit to Partial Upgrading of Bitumen (PUB)** – Does the product from the technology meet the definition of partial upgrading, or does it exceed the definition?
  - Does not meet
  - Meets
  - Exceeds
  - Unknown
- c) **Principles Behind Processing Technology**
  - Primary upgrading step
  - Secondary upgrading step
  - Olefin Treating – is treatment of produced olefins required in order to meet pipeline specifications?
    - YES
    - NO
- d) **Viability of Technology**
  - Technical Basis – Are the underlying engineering principles fully established, based at least on results from pilot testing?
    - YES
    - NO
    - Unknown
  - Market Basis defines the acceptance of the product(s)
    - High – Established products with defined markets. This designation applies to well established technologies such as coking, hydroconversion and Fischer-Tropsch
    - Medium – The products have attributes in common with heavy crudes and coker products, but are not identical and not on the market yet

- Unknown – Very different products to established markets or ill-defined early-stage processes
- Asphaltenes (+A) – The technology produces significant amounts of asphaltenes or similar byproducts for which no market has been defined yet and which may require disposal
- Environmental basis – GHG Emissions – How do the GHG emissions compare to established technologies?
  - Baseline or near-baseline – Similar to delayed coking
  - Below baseline – Lower than delayed coking
  - Medium – Higher than baseline due to significant hydrogen consumption or partial coke combustion
  - High – Complete coke combustion, gasification, or significant combustion of unconverted vacuum residue

**e) Potential location for the use of such a process**

- Integrated – The partial upgrader is located at the SAGD site and integrated with water treatment and steam generation
- Bolt-on – Add on to a SAGD central processing facility
- Central PUF – A centrally located Partial Upgrading Facility (PUF) collecting product from multiple SAGD fields

Table 5.5: Summary of Commercial and New Technologies for Partial Upgrading

Section	Technology	Technology Status	Fit to Partial Upgrading of Bitumen (PUB)	Principles Behind Processing Technology			Viability of Technology			Location
				Primary Step	Secondary Step(s)	Olefin Treating Required	Technical Basis	Market Basis	Environmental Basis (GHG)	SAGD Integrated
5.2.1.2	Delayed coking	Commercial	Exceeds	Coking		YES	YES	High	Baseline	Bolt-on or Central PUF
5.4.1.4	Alberta Taciuk Retort Process (ATP)	Commercial (for shale only)	Exceeds	Coking		YES	YES	Medium	High	Bolt-on
5.4.7.7	Expander Energy FT crude	Commercial (Sasol for coal)	Exceeds	Asphaltene rejection	Gasification of asphaltenes followed by Fischer Tropsch	NO	YES	High	High	Central PUF
5.4.2.1	Commercial PFT Process Block	Commercial	Meets - with diluent use	Solid asphaltene removal		NO	YES	High + A	Below baseline	Integrated or Bolt-on
5.2.2.1	Solvent Deasphalting	Commercial	Meets - with diluent use	Pumpable asphalt removal		NO	YES	High + A	Below baseline	Bolt-on
5.2.1.1	Visbreaking	Commercial	Meets - with diluent use	Mild thermal		YES	YES	Medium	Below baseline	Bolt-on
5.4.2.2	SELEX-Asp for Rejection of Solid Asphaltene	Commercial (China Crude)	Meets - with diluent use	Solid asphaltene removal		NO	YES	High + A	Below baseline	Bolt-on
5.4.6.1	Fractal Systems Jet Shear™/Enhanced Jet Shear™	Demonstration	Meets - with diluent use	Mild thermal	Fluid Mechanical	YES	YES	Medium	Below baseline	Bolt-on or Central PUF
5.4.1.1	Fluid Oil Viscositor (Ivanhoe HTL)	Demonstration	Exceeds	Coking		YES	YES	Medium	High	Bolt-on
5.4.1.3	Husky HDR™ - Hydrogen Donor Cracking with SCO	Pilot	Meets	Mild thermal		YES	YES	Medium	Below baseline	Bolt-on
5.4.3.1	MEG HI-Q® Partial Upgrading Technology	Pilot	Meets	Mild thermal	Solid asphaltene removal	YES	YES	Medium + A	Below baseline	Bolt-on or Central PUF
5.4.3.2	Nexen's BituMax™ Partial Upgrading Technology	Pilot	Meets	Asphaltene removal	Mild thermal	YES	YES	Medium + A	Below baseline	SAGD Integrated
5.4.3.4	VCI's ADC and COC Technologies	Pilot	Meets	Solid asphaltene removal	Coking	YES	YES	Medium + A	Medium	SAGD Integrated
5.4.3.3	Water-Based Supercritical Solvent Extraction (JGC)	Pilot	Meets	Mild thermal	Water extraction	YES	YES	Medium + A	High	SAGD Integrated
5.4.4.1	Hydrovisbreaking	Pilot	May meet	Mild thermal	Hydrotreating	NO	YES	Unknown	Near baseline	Bolt-on
5.4.1.2	ETX Systems IQ Technology	Pilot	Exceeds	Coking		YES	YES	Medium	Medium	Bolt-on
5.4.7.1	Field Upgrading - Molten Sodium Upgrading	Pilot	Exceeds on sulfur	Direct sulfur removal	Sodium regeneration	NO	YES	High for Fuel market	Below baseline	Bolt-on or Central PUF



Section	Technology	Technology Status	Fit to Partial Upgrading of Bitumen (PUB)	Principles Behind Processing Technology			Viability of Technology			Location
				Primary Step	Secondary Step(s)	Olefin Treating Required	Technical Basis	Market Basis	Environmental Basis (GHG)	SAGD Integrated
			Unknown on other properties							
5.4.1.5	Water-Based Catalytic Visbreaking (Aquaconversion)	Pilot	Does not meet	Mild thermal		YES	NO	Medium	Below baseline	Bolt-on
5.4.5.1	Superior Upgrading Tech./Hammer Technology	Pilot	Unknown	Fluid mechanical		Unknown	NO	Unknown	Below baseline	Bolt-on
5.4.7.3	Novel Diluent	Development	Does not meet	No partial upgrading achieved		NO	YES	High	Below baseline	Unknown
5.4.7.4	Bitumen solidification	Development	Does not meet	No partial upgrading achieved		NO	Unknown	Unknown	Below baseline	Unknown
5.4.7.5	Auterra Oxidative Desulfurization	Development	Unknown	Oxidation of sulfur	Aqueous hydrolysis	NO	NO	Unknown	Potentially below baseline	Unknown
5.4.5.2	Electromechanical based technologies	Development	Unknown	Various		YES	Unknown	Unknown	Unknown	Bolt-on
5.4.7.2	Novel Additive-Based Upgrading	Development	Unknown	Coking		Unknown	Unknown	Unknown	Unknown	Unknown
5.4.7.6	In Situ Upgrading	Development	Unknown	Various		Unknown	Unknown	Unknown	Unknown	SAGD-Integrated

## 5.6 Partial Upgrading Technology Selection

As we discussed, there are a number of promising technologies at varying stages of development that could be used to partially upgrade or fully upgrade bitumen. Partial upgrading technology selection should take the following criteria into consideration:

1. **Unable to meet partial upgrading specifications** – Visbreaking and solvent deasphalting are examples of commercial technologies that, by themselves, cannot meet the product specifications without diluent use. Newer deasphalting technologies, such as paraffinic froth treatment and Selex-Asp, are in the same category.
2. **Overconversion that exceeds partial upgrading specifications** – Commercial technologies based on coking, such as delayed coking and fluid coking, produce products that exceed the specifications for partial upgrading. These technologies would give much higher quality crude oil but at substantially higher cost.
3. **Excessive greenhouse gas emissions** – Technologies that incorporate significant combustion of coke, asphaltene, or residual materials may lead to high GHG emissions.
4. **Production of large amounts of low value or unwanted byproducts** – Technologies such as oxidized sulfur, and partially converted pitch from water-based supercritical conversion create large amounts of byproducts.
5. **Insufficient level of development, inactive development, or outside the scope of partial upgrading** – A number of technologies are no longer being actively developed. For example, Aquaconversion and Petrosonic.

Applying these criteria to the technologies listed in Table 5.5, two main themes emerge for potential pathways for partial upgrading to meet pipeline specifications with low or no diluent use:

1. Mild thermal cracking of bitumen to break down some of the large molecules, with or without enhancements such as fluid-mechanical manipulation or addition of other crude oil fractions. This approach maintains volumetric yield. However, diluent addition is still required and the stability of the thermally cracked asphaltenes are concerns.
2. Mild thermal cracking in combination with partial asphaltene rejection to produce a crude oil that meets pipeline specifications with no diluent addition or reduced diluent addition. This approach produces a stable crude oil and eliminates or reduces the need for diluent addition. However, there is some volumetric yield loss and production of asphaltene by-products for which no market exists.

The use of mild thermal cracking, common to both approaches, is based on its low cost and effectiveness in reducing bitumen viscosity. Despite long use in refining, details of how high temperatures modify the asphaltenes and their properties require better definition.

There are likely to be many more technologies that will be offered for partial upgrading of bitumen in the future. Choosing which ones to pursue should be based on their providing a solid scientific basis for technical claims. New partial upgrading technologies must also address issues concerning bitumen and bitumen transport discussed here, namely reducing or eliminating the need for diluent by reducing or rejecting asphaltenes, and converting heavy molecules to lighter ones. Because it is expensive to build new technology in Alberta, low capital cost and high yield are other key attributes of successful partial upgrading technology.

## 6. Summary of Challenges and Recommendations

Challenges remain on the path to commercialization of bitumen partial upgrading technology. These include: changing market conditions, logistical barriers, mismatches between properties desired by crude oil refiners and achieved by partial upgrading, high capital and operating costs, yield loss, GHG impact, lack of scale, and technical risks. However, multiple pilots, R&D work, and government support are underway to mitigate many of these issues.

### 6.1 Recommendations for Further Research and Development

The following key topics are recommended for further research and development:

1. Viscosity reduction of partially upgraded bitumen with minimal energy input, and without producing unstable asphaltenes in the product – Alternatives to mild thermal cracking could be valuable, to reduce energy consumption and avoid changes to the stability of the asphaltenes.
2. Asphaltene stability in thermally cracked partially upgraded bitumen is a potential fouling issue for downstream refineries, because thermally cracked asphaltenes may become unstable when blended with other crude oils in the refinery. Research on the relationship between metrics of asphaltene stability and fouling could be helpful in increasing the market acceptance of partially upgraded bitumen.
3. Olefin reduction in partially upgraded bitumen without hydrogen addition – The existing technology for olefin reduction is based on expensive hyrotreatment. Alternatives that convert or separate the olefin components without the use of hydrogen could reduce the cost of partial upgrading processes.
4. Uses for rejected asphaltenes from partial upgrading – The removal of a portion of the asphaltenes from the bitumen enhances the product quality and value, but it creates a byproduct for which markets do not exist. Research on new products from asphaltenes could provide alternatives for the use of this material.
5. Impact of quality improvement on price of partially upgraded bitumen – Partial upgrading can improve the quality of the product by reducing MCR and sulfur and increasing the fraction of distillates. The value of these improvements to refineries needs to be investigated at current crude oil prices.
6. TAN reduction in partially upgraded bitumen. Thermal processing gives a reduction in TAN by breaking down a portion of the carboxylic acids, but alternate approaches are desirable.

## Appendix A: Glossary and List of Acronyms

### Glossary of Selected Terms Commonly Used in Oilsands Upgrading

<b>Acid gas</b>	A gas mixture containing hydrogen sulfide, and possibly carbon dioxide. The components from acid gas partition into aqueous solutions and lower the pH.
<b>Aliphatic</b>	Hydrocarbon compounds or fragments of larger molecules comprised of saturated carbons, in CH, CH <sub>2</sub> and CH <sub>3</sub> groups depending on the specific structure.
<b>°API</b>	A measure of liquid gravity defined by the American Petroleum Institute and common in the oil industry, derived from the Baume scale. The liquid gravity of water is set at 10 °API. If an oil has a gravity greater than 10 °API, it is less dense and floats on water; if less than 10 °API, it is more dense than water and sinks. Light crudes have gravities of 35–40 °API. Bitumens by convention typically have gravities below 10 °API.
<b>Aromaticity</b>	The fraction of carbon in a compound or a petroleum fraction that is in aromatic rings (see Aromatics)
<b>Aromatics</b>	Hydrocarbon species containing at least one planar ring with delocalized p-electrons, usually represented as alternating double and single bonds. Such molecules are typically more stable than similar non-aromatic structures toward thermal cracking. Aromatics occur in unusually high concentrations in bitumen and some derived products, and the presence of aromatics decreases the quality of distillate fuels. The simplest compound in the aromatic series is benzene.
<b>Asphaltenes</b>	The heaviest and most aromatic hydrocarbon fraction of bitumen, isolated by precipitation with a paraffinic solvent such as n-pentane or n-heptane.
<b>Asphaltene Micelle</b>	Organization of relatively more polar asphaltene molecules in a relatively less polar hydrocarbon solution. Solubilization of asphaltene molecules in a hydrocarbon solution can be achieved by surfactant molecules like maltenes. As maltenes are converted in partial upgrading, asphaltene solubility decreases and they begin to precipitate.
<b>Barrel (bbl)</b>	The generally accepted commercial unit of measurement for oil. One barrel of oil equals 159 liters, and one cubic meter of oil contains 6.29 barrels. Within the oil industry, the abbreviation “Mbbbl” was used to symbolize thousands of barrels, and “MM bbl” millions of barrels. However, many in the industry now use SI prefixes instead; that is, “kbbbl” for thousands of barrels and “Mbbbl” for millions of barrels.

<b>Biodiesel</b>	Diesel fuel from fats and oils. It is a fatty acid methyl ester.
<b>Boiling curve</b>	The continuous relationship between the cumulative mass or volume of a petroleum or bitumen sample that is distilled into vapor and the boiling temperature of the liquid. The curve begins at the initial boiling point (IBP) and ends at the final boiling point (FBP) or at the limiting temperature for distillation in the case of heavy bitumen fractions. The limits are around 524 °C for vacuum distillation and 750 °C for simulated distillation.
<b>Bottom solids and water (BS&amp;W)</b>	The volume fraction of a crude oil that consists of water and solid particles, determined by adding solvent and centrifugation.
<b>Bromine number</b>	A measure of the concentration of olefins (or alkene groups) in a sample, based on the reaction of bromine (Br <sub>2</sub> ) with these compounds.
<b>Buffer shipment</b>	A pipeline shipment of crude oil that is used to separate material with undesirable olefins content for previous and subsequent pipeline batches.
<b>Carbon number</b>	The number of carbon atoms in a compound, often used to relate properties to the paraffinic compound series.; C <sub>6</sub> = n-hexane, C <sub>10</sub> =n-decane, C <sub>16</sub> =n-hexadecane etc.
<b>Catalyst</b>	A material that increases the rate of a chemical reaction but is not consumed by the reaction. Catalysts are used in upgrading processes to assist hydrogenation, sulfur and nitrogen removal, cracking and other upgrading reactions.
<b>Cetane number</b>	A measure used to describe the combustion characteristics of a diesel fuel. A high cetane number indicates a better fuel. The scale is from zero for naphthalene to 100 for n hexadecane (cetane)
<b>Coke</b>	The solid black residue of carbon, sulfur, nitrogen, hydrogen and metals that remains after the more valuable components have been removed (from bitumen) by heating to high temperatures.
<b>Condensate</b>	A mixture of light hydrocarbons recoverable from gas reservoirs, mainly in the range from C <sub>5</sub> to C <sub>6</sub> ; also called natural gas liquid, natural gas condensate, natural gasoline or pentanes plus. Condensate is used as a diluent to reduce bitumen viscosity for pipeline transportation.
<b>Conradson carbon residue (CCR)</b>	The amount of solid carbonaceous residue from a sample, as a weight fraction, from thermal cracking under standardized conditions. CCR content is proportional to the yield of coke in coking processes. The CCR assay has largely been replaced by the simpler Micro-Carbon Residue (MCR) assay which gives equivalent results.

<b>Cracking</b>	The process of breaking down larger, heavier and more complex hydrocarbon molecules into simpler, lighter molecules by thermal or catalytic reactions.
<b>CAFE</b>	Corporate average fuel standards (CAFE) are established by the US EPA and National Highway Transportation Safety Administration (NHTSA) for light duty vehicles.
<b>CO<sub>2e</sub></b>	CO <sub>2</sub> equivalents, which GHG emissions from CO <sub>2</sub> and NO <sub>x</sub> and CH <sub>4</sub> converted to CO <sub>2</sub> equivalents by their global warming potentials
<b>Deasphalting</b>	A family of processes that use light solvents to selectively separate highly aromatic asphaltene fractions from heavy feeds. The two products are asphaltenes (or asphalt) and a deasphalted oil (DAO).
<b>Diluent</b>	A solvent added to bitumen or heavy oil to reduce its viscosity and raise its API gravity to allow pipeline transportation. Diluents include natural gas condensate (see Condensate), naphtha, and synthetic crude oil.
<b>Diluted bitumen (dilbit)</b>	A mixture of crude bitumen and a diluent (solvent).
<b>Distillate</b>	A fraction of bitumen or synthetic crude oil than can be recovered as the overhead stream from distillation.
<b>Distillation curve</b>	See Boiling curve.
<b>EPA</b>	US Environmental Protection Agency
<b>Flue gas desulfurization</b>	Scrubbing processes for removing sulfur dioxide from gas streams after combustion of fuels.
<b>Fouling</b>	Deposition of solid layers on surfaces in heat transfer equipment such as heat exchangers and process furnaces; accumulation of deposits in any process vessel that may eventually impede flow and performance.
<b>Fraction</b>	A separate, identifiable part of crude oil that can be isolated by refining, distillation, precipitation or chromatographic separation.
<b>Gas oil</b>	A mid-range distillate fraction of petroleum or synthetic crude oil, typically with boiling points of 177–524 °C. Gas oils in the upper end of this temperature range require distillation under a vacuum and are called vacuum gas oils (VGO).
<b>Gasification</b>	A process to partially oxidize any hydrocarbon (usually heavy residues) to a mixture of hydrogen and carbon monoxide. Gasification can also be used to produce hydrogen and synthesis gas for making petrochemical products.
<b>Heavy crude oil</b>	Oil with a gravity below 22 °API. Heavy crudes must be blended with condensate before they can be shipped by pipeline.

<b>Heavy gas oil</b>	A gas oil with a boiling range mainly above 343 °C (see Gas oil).
<b>Hydrocarbons</b>	Chemical compounds of hydrogen and carbon that form the basis of all petroleum products. Hydrocarbons may be solid, liquid or gaseous.
<b>Hydroconversion</b>	An upgrading process that converts vacuum residue to distillates using high temperatures (above 410 °C), high-pressure hydrogen and a catalyst. The catalyst may be either pellets of ceramic impregnated with active metal sulfides or fine particles of metal sulfides. The high temperature cracks the molecules and the catalyst prevents coke formation. The main licensed hydroconversion technologies are LC-Fining and H-Oil.
<b>Hydrocracking</b>	A refining process that converts heavy gas oil into lighter fractions using hydrogen and a bifunctional catalyst. The catalyst has both hydrogenation and acid cracking activity. The feed material is normally vacuum gas oil and/or deasphalted oil.
<b>Hydrodemetallation (HDM)</b>	Removal of Ni and V from petroleum streams through reactions with hydrogen over a metal sulfide catalyst.
<b>Hydrodenitrogenation (HDN)</b>	Removal of nitrogen from petroleum streams through reactions with hydrogen over a metal sulfide catalyst.
<b>Hydrodesulfurization (HDS)</b>	Removal of sulfur from petroleum streams through reactions with hydrogen over a metal sulfide catalyst.
<b>Hydroprocessing</b>	A range of upgrading processes that catalytically hydrogenate petroleum fractions to improve their quality, including hydroconversion, hydrocracking and hydrotreating. This term is often used interchangeably with hydroconversion, most commonly for fixed-bed reactors.
<b>Hydrotreating</b>	A process that removes sulfur, nitrogen, and olefins from the components of synthetic crude oil by the catalytic addition of hydrogen in the final stage in the upgrading process. Separate units are used to hydrotreat naphtha and gas oil. The main reactions are hydrodesulfurization (HDS) and hydrodenitrogenation (HDN).
<b>Isoparaffins</b>	Branched paraffins.
<b>Kerosene</b>	Middle distillate fraction of petroleum traditionally used for heating or lighting.
<b>Light crude oil</b>	Liquid petroleum with a gravity of 28 °API or higher. A high-quality light crude oil might have a gravity of 40 °API. Upgraded crude oils from the oil sands have values of around 33 °API (compared to 32–34 °API for Light Arab and 42 °API for West Texas Intermediate).
<b>Light ends</b>	Gaseous components in distillation and conversion processes, usually consisting of C1-C4 hydrocarbons.
<b>Light gas oil</b>	Lowest boiling range of gas oil, usually boiling below 424 °C.



<b>Liquid hourly space velocity (LHSV)</b>	The volume of a reactor divided by the hourly liquid feed rate at standard conditions of temperature and pressure.
<b>Maltenes</b>	The fraction of crude oil that is not asphaltenes, i.e. soluble in n-heptane.
<b>Mesophase</b>	Coke material that has ordered molecules giving liquid-crystal behavior, also called carbonaceous mesophase.
<b>Middle distillate</b>	Fraction of crude oil or process streams boiling between 177 and 343 °C.
<b>Naphtha</b>	Light distillate from cracked products or synthetic crude. Naphtha is most commonly defined as the distillate fraction with a boiling point below 177 °C.
<b>Naphthenes</b>	Cyclic paraffin; saturated hydrocarbons containing one or more rings, e.g. cyclohexane.
<b>Naphthenic acid</b>	Acid components in the bitumen that have a carboxylic acid group attached to a hydrocarbon tail, most commonly a cyclic paraffin (which is also known as a naphthene). These acids are important surface active components (surfactants) in the extraction process but cause corrosion in upgrading operations.
<b>NHTSA</b>	US National Highway Transportation Safety Administration
<b>Olefin</b>	A hydrocarbon compound containing a single double bond or unsaturation; also called an alkene. Olefins are formed during thermal and catalytic cracking of bitumen fractions. Diolefins contain two double bonds per molecule and are prone to fouling equipment through the formation of polymers.
<b>Paraffin</b>	A straight-chain hydrocarbon of the elemental formula $C_nH_{2n+2}$ ; the formal chemical term is n-alkane.
<b>Petroleum</b>	A complex mixture of a wide range of hydrocarbons and non-hydrocarbon liquid components in various combinations. Commonly called crude oil.
<b>PFT</b>	Paraffinic froth treatment - removal of water and fine solids from bitumen froth by precipitating a portion of the asphaltenes using a paraffinic solvent such as hexane.
<b>Polynuclear aromatic hydrocarbon (PAH)</b>	Aromatic compounds with more than one ring in a fused structure.
<b>RFS</b>	Renewable fuel standard. A US EPA requirement for the type and quantity of renewable fuel used in vehicle fuel

<b>Renewable diesel</b>	Diesel from renewable sources that is indistinguishable from hydrocarbon based diesel fuel. It is often produced by hydrotreating fats and oils from biological sources.
<b>Residue, vacuum residue or residuum (resid)</b>	The fraction of bitumen or petroleum with a boiling point over 524 °C.
<b>SARA</b>	Fractionation of petroleum by precipitation and chromatography into saturates, aromatics, resins and asphaltenes.
<b>Simulated distillation</b>	Calculation of a boiling curve from gas chromatographic separation of a sample.
<b>Solubility parameter</b>	A measure of the solvent power of a liquid.
<b>Sour</b>	Containing sulfur compounds, as in sour crude oil.
<b>Synthetic crude oil</b>	A high-quality light sweet crude oil manufactured by upgrading oilsands bitumen, composed of a blend of processed distillate fractions. The crude bitumen is upgraded through the addition of hydrogen or the removal of coke.
<b>Total acid number (TAN)</b>	A measure of the concentration of acid components in a crude oil.
<b>Upgrading</b>	Conversion of bitumen into a lighter, sweeter, high-quality crude oil through either the removal of highly aromatic and high-molar-mass components (coking) or the addition of hydrogen (hydroconversion).
<b>Vacuum distillation</b>	Distillation under reduced pressure to recover high-boiling compounds (See Distillation).
<b>Vacuum gas oil (VGO)</b>	Petroleum fraction recovered by distillation under vacuum, with a boiling range from 343 – 524 °C.
<b>Vacuum residue</b>	The fraction of crude oil remaining after vacuum distillation, with a majority of components boiling over 524 °C.
<b>Visbreaking</b>	A process that reduces residue viscosity by thermal cracking without any appreciable degree of coke formation.
<b>Viscosity</b>	The ability of a liquid to flow; the lower the viscosity, the more easily the liquid will flow. Dynamic viscosity is defined as the ratio between the stress exerted by the fluid when subjected to a rate of strain, which is the gradient in the velocity. Kinematic viscosity is the dynamic viscosity divided by the density of the fluid.
<b>WTW</b>	Well-to-wheels – the boundaries for analysis of energy consumption and greenhouse gas emissions from producing a crude oil, transporting to upgrading or refining, refining of the crude oil, distribution of refined products to end users, and end use

<b>West Texas Intermediate (WTI)</b>	Reference crude oil for the United States.
<b>Western Canada Select (WCS)</b>	A bitumen blend produced by several companies in Western Canada.

#### **Common Acronyms for Upgrading**

<b>AWB</b>	Access Western Blend, a diluted Athabasca bitumen
<b>BPD</b>	Barrels per day
<b>BPSD</b>	Barrels per standard day
<b>BS&amp;W</b>	Bottom solids and water
<b>CCR</b>	Conradson carbon residue
<b>DAO</b>	Deasphalted oil
<b>HDN</b>	Hydrodenitrogenation (see Hydrotreating)
<b>HDS</b>	Hydrodesulfurization (see Hydrotreating)
<b>HGO</b>	Heavy gas oil
<b>KBPD</b>	Kilo barrels per day
<b>Wh</b>	Micro-carbon residue; the solid residue or coke that remains after heating a sample of oil to 500 °C using a standard test protocol.
<b>PAH</b>	Polynuclear aromatic hydrocarbon
<b>SAGD</b>	Steam-assisted gravity drainage (see in situ recovery and Steam-assisted gravity drainage)
<b>SCFE</b>	Supercritical fluid extraction
<b>SCO</b>	Synthetic crude oil
<b>TAN</b>	Total acid number
<b>TBP</b>	True boiling point
<b>VGO</b>	Vacuum gas oil (see Gas oil)
<b>VTB</b>	Vacuum-topped bitumen, a mixture of VGO and vacuum residue
<b>WCS</b>	Western Canada select
<b>WTI</b>	West Texas intermediate

## Appendix B References

**Agawal, P., et al. 2012.** Measurement and modeling of the phase behavior of solvent diluted bitumens : Fluid Phase Equilib., 2012, Vols. 334: 51-64.

**Alberta Energy Regulator. 2017.** 2017: ST98:2017 Alberta's Energy Reserves & Supply/Demand Outlook. [Online] 2017. [http://www1.aer.ca/st98/data/executive\\_summary/ST98-2017\\_Executive\\_Summary.pdf](http://www1.aer.ca/st98/data/executive_summary/ST98-2017_Executive_Summary.pdf).

**Alshareef, A.H., et al. 2011.** Formation of archipelago structures during thermal cracking implicates a chemical mechanism for the formation of petroleum asphaltenes : Energy Fuels, 2011, Vols. 25: 2130-2136.

**Amani, M.J., Gray, M.R. and Shaw, J. M. 2014.** On correlating water solubility in ill-defined hydrocarbons : Fuel, 2014, Vols. 134: 644-658.

**Arahata, Y., et al.** Upgrading of Oil Sands Bitumen (Part 2) Effect of Hydrovisbreaking as Pretreatment to Catalytic Demetallization and Hydrocracking : Sekiyu Gakkaishi, Vols. 31, No. 4, 1988.

**ASTM. 2017.** ASTM D4530, Standard Test Method for Determination of Carbon Residue (Micro Method). [Online] 2017. <https://www.astm.org/Standards/D4530.htm>.

**Auterra. 2017.** Flex UP Process. [Online] 2017. <https://auterrainc.com/pdf/flexup-overview.pdf>.

**Avid, B., et al. 2006.** Effect of n-pentane and n-heptane insolubles on the pyrolysis of vacuum residue : Energy Fuels, 2006, Vols. 20(6): 2475-2477.

**Baldassari, M. and Mukherjee, U. 2012.** LC-MAX and Other LC-FINING Process Enhancements to Extend Conversion and Onstream Factor, : AFPM, 2012, Vols. AM-12-73. Chveron Lummus Global.

**Barre, L., Simon, S. and Palermo, T. 2008.** Solution properties of asphaltenes : Langmuir, 2008, Vols. 24(8): 3709-3717.

**Barton, A.F.M. 1991.** *CRC handbook of solubility parameters and other cohesion parameters, second editio.* Boca Raton, FL : CRC Press., 1991.

**Bayshore Petroleum. 2015.** Partial Upgrading--Bitumen to Synthetic Crude Oil. *Bayshore Petroleum.* [Online] 2015. <http://www.bayshorepetroleum.com/>.

**Bazyleva, A.B, et al. 2010.** 1389-1397., Bitumen and heavy oil rheological properties: Reconciliation with viscosity measurements : J. Chem. Eng. Data, 2010, Vol. 55.

**Beccari, M. and Romano, U. 2006.** *Encyclopaedia of hydrocarbons. / [Vol. II, Refining and petrochemicals].* s.l. : ENI : Istituto della Enciclopedia italiana, cop, 2006.

**Beeston, S. 2014.** Dubai : ME Tech, 2014. SOLVENT DEASPHALTING OPTIONS How SDA can increase residue upgrading margins, AMEC/Foster Wheeler.

**Bowman, R.D. and Davidson, N. 1972.** Hydrodynamic shear breakage of DNA : Biopolymers, 1972, Vols. 11(12): 2601-2624.

**BP. 2017.** BP Statistical Review of World Energy 2017. *bp.com.* [Online] 2017. <https://www.bp.com/en/global/corporate/energy-economics/statistical-review-of-world-energy.html>.

**Brons, G. and Yu, J. M. 1995.** Solvent deasphalting effects on whole cold lake bitumen : Energy Fuels, 1995, Vols. 9: 641-647.

**Brons, G., et al. 2001.** *Process for desulfurization of petroleum feeds utilizing sodium metal.* 6,210,564. US, 2001.

**Brown, W. 2009.** Edmonton, AB : 5th NCUT Upgrading and Refining Conference - lq upgrading at a 1 bbl/d scale, 2009.

**CAPP. 2017.** 2017 Crude Oil Forecast, Markets, and Transportation. [Online] 2017. <https://www.capp.ca/publications-and-statistics/crude-oil-forecast>.

**CAPP-2. 2017.** Canadian and U.S. Crude Oil Pipelines and Refineries - 2017. [Online] 2017. <https://www.capp.ca/publications-and-statistics/crude-oil-forecast>.

**Carlson, C.S., et al. 1958.** Thermal hydrogenation. Transfer of hydrogen from tetralin to cracked residua : Ind. Eng. Chem., 1958, Vols. 53: 1067-1070.

**Castaneda, L.C., Munoz, J.A.D. and Ancheyta, J. 2014.** Current situation of emerging technologies for upgrading of heavy oils : Catalysis Today, 2014, Vols. 220– 222 (2014) 248– 273.

**Cataldo, F. 2000.** Ultrasound-induced cracking and pyrolysis of some aromatic and naphthenic hydrocarbons : Ultrasonics Sonochemistry, 2000, Vols. 7(1): 35-43.

**CERI. 2015.** CERI Commodity Report — Crude Oil: New Upgrading Technology Holds Promise. [Online] 2015. <https://www.ceri.ca/market-updates/new-upgrading-technology-holds-promise>.

**Chacón-Patiño, M., S. M. Rowland and R. P. Rodgers. 2017.** Advances in asphaltene petroleomics. Part 1: Asphaltenes are composed of abundant island and archipelago structural motifs : Energy Fuels: DOI: 10.1021/acs.energyfuels.1027b02873., 2017.

**Cheng, Z.M., et al. 2009.** Effects of supercritical water in vacuum residue upgrading : Energy Fuels, 2009, Vols. 23: 3178-3183.

**Chornet, M. and Chornet, E. 2008.** *Process for treating heavy oils. 2,814,773.* Canada, 2008.

—. 2008. *Process for treating heavy oils. 2814773 A1* assigned to Fractal Systems, 2008.

**Chung, K. H., et al. 1998.** The chemistry, reactivity and processability of athabasca bitumen pitch : Rev. Process Chem. Eng., 1998, Vols. 1: 41-79.

**Chung, K.H., et al. 2006 Q4.** Asphaltene removal from heavy oil. *Petroleum Technology Quarterly.* 2006 Q4.

**Crude Monitor. 2017.** [crudemonitor.ca](http://www.crudemonitor.ca/). [Online] 2017. <http://www.crudemonitor.ca/>.

**Dawson, W.H., et al. 1992.** *Process for reducing the viscosity of heavy hydrocarbon oils. 5,096,566 A.* US, 1992.

**Dutta, R.P., et al. 2000.** Thermal cracking of athabasca bitumen: Influence of steam on reaction chemistry : Energy Fuels, 2000, Vols. 14(3): 671-676.

**Duyvesteyn, W.P.C., Salazar, J.A. and Ard, C.D. 2011.** *Systems and methods for processing nozzle reactor pitch.* 2011046660 A1 WPO, 2011.

**EIA. 2017.** eia.gov. [Online] 2017.

[https://www.eia.gov/beta/international/data/browser/#/?pa=000000000000000000000008&c=ruvvvvfvvtvnnv1urvvvfvvvvvfvvvou20evvvvvvvvnnvuvo&ct=0&tl\\_id=5-A&vs=INTL.57-6-AFG-](https://www.eia.gov/beta/international/data/browser/#/?pa=000000000000000000000008&c=ruvvvvfvvtvnnv1urvvvfvvvvvfvvvou20evvvvvvvvnnvuvo&ct=0&tl_id=5-A&vs=INTL.57-6-AFG-)

**EIA-10. 2013.** Crude oils have different quality characteristics. [Online] 2013.

<https://www.eia.gov/todayinenergy/detail.php?id=7110>.

**EIA-11.** Weekly Inputs & Utilization. eia.gov. [Online]

[https://www.eia.gov/dnav/pet/pet\\_pnp\\_wiup\\_dcu\\_nus\\_4.htm](https://www.eia.gov/dnav/pet/pet_pnp_wiup_dcu_nus_4.htm).

**EIA-12. 2017.** Tight oil expected to make up most of U.S. oil production increase through 2040. eia.gov.

[Online] 2017. <https://www.eia.gov/todayinenergy/detail.php?id=29932>.

**EIA-2. 2017.** [Online] 2017. <https://www.eia.gov/petroleum/marketing/monthly/pdf/paddmap.pdf>.

**EIA-3 Plotted by Jacobs. 2017.** Number and Capacity of Petroleum Refineries. [Online] 2017.

[http://www.eia.gov/dnav/pet/pet\\_pnp\\_cap1\\_dcu\\_nus\\_a.htm](http://www.eia.gov/dnav/pet/pet_pnp_cap1_dcu_nus_a.htm).

**EIA-4. 2017.** U.S. Energy Information Administration 2017:PADD level imports of crude oil by country.

[Online] 2017. [http://www.eia.gov/dnav/pet/pet\\_pnp\\_crq\\_a\\_epc0\\_ycs\\_pct\\_m.htm](http://www.eia.gov/dnav/pet/pet_pnp_crq_a_epc0_ycs_pct_m.htm).

**EIA-5. 2017.** U.S. Energy Information Administration 2017:Crude movement by rail. [Online] 2017.

[https://www.eia.gov/dnav/pet/pet\\_move\\_railna\\_a\\_epc0\\_rail\\_mbb1\\_m.htm](https://www.eia.gov/dnav/pet/pet_move_railna_a_epc0_rail_mbb1_m.htm).

**EIA-6. 2017.** U.S. Energy Information Administration 2017:Annual Energy Outlook 2017. [Online] 2017.

<https://www.eia.gov/outlooks/aeo/>.

**EIA-7. 2017.** U.S. Energy Information Administration 2017:Sulfur and API gravity of crude processed in US. [Online] 2017.

[http://www.eia.gov/dnav/pet/pet\\_pnp\\_crq\\_a\\_epc0\\_ycs\\_pct\\_m.htm](http://www.eia.gov/dnav/pet/pet_pnp_crq_a_epc0_ycs_pct_m.htm).

**EIA-8. 2017.** U.S. Energy Information Administration 2017:Annual imports by API gravity. [Online] 2017.

[http://www.eia.gov/dnav/pet/pet\\_move\\_ipct\\_k\\_m.htm](http://www.eia.gov/dnav/pet/pet_move_ipct_k_m.htm).

**EIA-9. 2017.** U.S. Energy Information Administration 2017:Company Level Imports. [Online] 2017.

<https://www.eia.gov/petroleum/imports/companylevel/archive/>.

**EPA. 2016.** Final Rule for Greenhouse Gas Emissions and Fuel Efficiency Standards for Medium- and Heavy-Duty Engines and Vehicles - Phase 2. [Online] 2016. <https://www.epa.gov/regulations-emissions-vehicles-and-engines/final-rule-greenhouse-gas-emissions-and-fuel-efficiency>.

**EPA RFS. 2018.** Renewable Fuel Standard Program. epa.gov. [Online] 2018.

<https://www.epa.gov/renewable-fuel-standard-program>.

**ETX Systems. 2017.** IYQ Upgrading. [Online] 2017.

<http://www.etxsystems.com/Publications/Presentations/ETX%20presentation%20for%20TDP%20July%202017.pdf>.

**Expander Energy. 2017.** FTCrude. <http://www.expanderenergy.com>. [Online] Expander Energy, 2017.

<http://www.expanderenergy.com/ftcrudereg.html>.

**ExxonMobil. 2017.** FLUID COKING™ Conversion Technology. [Online] 2017.  
<http://www.digitalrefining.com/data/literature/file/523514257.pdf>.

**Fathi, M.M. and Pereira-Almao, P. 2011.** Catalytic aquaprocessing of arab light vacuum residue via short space times : Energy Fuels, 2011, Vols. 25(11): 4867-4877.

**Fellows, G.K., et al. 2017.** 1, Public Interest Benefit Evaluation of Partial Upgrading Technology : University of Calgary School of Public Policy, 2017, SPP Research Papers, Volume 10 • Issue 1, Vols. SPP Research Papers, Volume 10 • Issue 1.

**FERC. 2018.** Federal Regulatory Commission. *Source: Waterborne Energy, Inc. Data in \$US/MMBtu. Landed prices are based on a netback calculation.* [Online] 2018. <https://www.ferc.gov/market-oversight/mkt-gas/overview/archives.asp>.

**Field Upgrading. 2017.** De-Sulphurization & Upgrading (DSU™),. [Online] 2017.  
<http://www.fieldupgrading.com/technology/overview>.

**Field Upgrading. 2015.** Edmonton, AB : World Heavy Oil Conference, 2015. Desulfurizing and upgrading the bottom of the barrel.

**Fluid Oil Corp. 2017.** VHTL Technology. [Online] 2017. <http://fluidoilcorp.com/vhtl-technology/vhtl-technology/>.

**Fractal Systems. 2016-2017.** Understanding the Value Proposition of the JetShear™. Technology Platform. 2016-2017. <http://fractalsys.com/>.

**Fumoto, E., et al. 2009.** Recovery of lighter fuels by cracking heavy oil with zirconia-alumina-iron oxide catalysts in a steam atmosphere : Energy Fuels, 2009, Vols. 23: 1338-1341.

**Fumoto, E., et al. 2015.** Catalytic cracking of heavy oil with iron oxide-based catalysts using hydrogen and oxygen species from steam : J. Jpn. Pet. Inst, 2015, Vols. 58(5): 329-335.

**Gary, J.H., Handwerk, G.E. and Kaiser, M.J. 2007.** *Petroleum Refining, 5th Edition.* NY : CRC Press, 2007. 311-312.

**Gordon, J. 2018.** UPDATE 1-Canadian city argues Trans Mountain pipeline route harmful,. *Reuters.* January 23, 2018.

**Gould, K.A. and Wiehe, I.A. 2007.** Natural Hydrogen Donors in Petroleum Resids : Energy Fuels, 2007, Vols. 21 (3), pp 1199–1204.

**Gray, M.R. 2002.** 1, New technique defines the limits of upgrading heavy oil, bitumens : Oil Gas J., 2002, Vol. 100.

**Gray, M.R. and McCaffrey, W.C. 2002.** Role of chain reactions and olefin formation in cracking, hydroconversion and coking of petroleum and bitumen fractions : Energy Fuels, 2002, Vols. 16: 756-766.

**Gray, M.R. 2015.** Upgrading oilsands bitumen and heavy oil. *Upgrading oilsands bitumen and heavy oil.* Edmonton : University of Alberta Press., 2015.

**Habib, F., et al. 2013.** Suppression of addition reactions during thermal cracking using hydrogen and sulfide catalyst : Energy Fuels, 2013, Vols. 27: 6637-6645.

**Hashemi, R. 2013.** In-Situ Upgrading and Recovery Enhancement of Athabasca Bitumen by Ultra-Dispersed. Calgary, AB : University of Calgary, 2013. Vol. PhD thesis.  
[https://prism.ucalgary.ca/bitstream/handle/11023/1189/UCalgary\\_2013\\_Hashemi\\_Rohallah.pdf?sequence=4](https://prism.ucalgary.ca/bitstream/handle/11023/1189/UCalgary_2013_Hashemi_Rohallah.pdf?sequence=4).

**Haverly Chevron Crude Assay Library - with Jacobs Analysis. 2016.** *Chevron Crude Oil Assay Library*. 2016.

**Henderson, J. H. and Weber, L. 1965.** Physical upgrading of heavy crude oils by the application of heat : *Journal of Canadian Petroleum Technology*, 1965, Vols. 4: 206-212.

**Husky. 2017.** *Private communication 2017*. 2017.

**Jacobs Consultancy. 2017.** Meeting New Fuel Requirements – Providing a Compass in Uncertain Times : American Fuel and Petrochemical Manufacturers 2017 Annual Conference, 2017. AM-17-20.

**Jacobs Consultancy. 2016.** *Oil-Climate Index Review Final Report Prepared for Alberta Department of Energy*. 2016.

**JacobsConsultancy. 2012.** *EU Pathway Study: Life Cycle Assessment of Crude Oils in a European Context for Alberta Dept. of Energy*. 2012.

**Jang, B. 2017.** Suncor cancels Voyageur project, takes hit to profit. *Globe and Mail*. March 26, 2017.

**Kayukawa,, T., et al. 2017.** Development of Supercritical Water Cracking Process to Upgrade Unconventional Extra Heavy Oil at Wellhead : *Journal of the Japan Petroleum Institute*, 2017, Vols. 60 (5), 241-247, 2017.

**Kinder Morgan. 2017.** [Online] 2017.  
<https://www.kindermorgan.com/business/canada/transmountain.aspx>.

**Kostrov , S.A., et al. 2011.** *Method and apparatus for treatment of crude oil or bitumen under auto-oscillation conditions for viscosity decrease*. 20110005973A1 US Patent Application, 2011.

**Kuijpers, M. W. A., et al. 2004.** The mechanism of cavitation-induced polymer scission; experimental and computational verification : *Polymer*, 2004, Vols. 45(19): 6461-6467.

**Langer, A.W., et al. 1962.** Hydrogen donor diluent visbreaking of residua : *Industrial & Engineering Chemistry Process Design and Development*, 1962, Vols. 1(4): 309-312.

**Langer, A.W., et al. 1961.** Thermal hydrogenation of crude residua : *Ind. Eng. Chem.*, 1961, Vols. 53: 27-30.

**Lu, B., Fu, C.Y. and Fu, C.T. 1989.** Phase equilibria and pvt properties. [book auth.] L. G. Hepler and C. Hsi. *Aostr technical handbook on oil sands, bitumens, and heavy oils*. Edmonton, AB : AOSTRA: 131-151., 1989.

**McKenna, A.M.,L. J. Donald, J. E. Fitzsimmons, P. Juyal, V. Spicer, K. G. Standing, A. G. Marshall and R. P. Rodgers, et al. 2013.** 3, Heavy petroleum composition. 3. Asphaltene aggregation. : *Energy Fuels*, 2013, Vol. 27. 1246-1256..

**MEG-1. 2017.** Private Communication. 2017.



**Mitchell, D.L. and Speight, J. G. 1973.** The solubility of asphaltenes in hydrocarbon solvents : Fuel, 1973, Vols. 52: 149-152.

**MOGAS-2. 2017.** Delayed Coking Product Brochure. [Online] 2017. <https://www.mogas.com/en-us/industries/refining>.

**Moschopedis, S.E. and Speight, J.G. 1977.** Effect of air blowing on properties and constitution of a natural bitumen : J. Mater. Sci., 1977, Vols. 12(5): 990-998.

**Muse Stancil. 2015.** *Stage 1 Parametric Analysis of Partially Upgraded Bitumen for Alberta Innovates Energy and Environment Solutions*. Dallas : Muse Stancil Inc. , 2015.

**Naghizada, N., Prado, G. H. C. and de Klerk , A.** Uncatalyzed hydrogen transfer during 100–250 °C conversion of asphaltenes : Energy Fuels, Vols. 31: 6800–6811.

**National Energy Board. 2017.** 2016 Oil Exports Statistics Summary. [Online] 2017. <https://www.nbe-one.gc.ca/nrg/sttstc/crdlnptrlmprdt/stt/crdlsmmr/2016/smmry2016-eng.html>.

**Nelson, W.L. 1958.** *Petroleum refinery engineering (4th edition)*. New York, NY : McGraw-Hill., 1958.

**Nexen. 2017.** Public Statements and Private Communication 2017. 2017.

**NHTSA. 2017.** Corporate Average Fuel Economy. <https://www.nhtsa.gov>. [Online] 2017. <https://www.nhtsa.gov/laws-regulations/corporate-average-fuel-economy>.

**Oil and Gas Journal. 2001.** Aquaconversion technology offers added value to E. Venezuela synthetic crude oil production, : Oil and Gas Journal, 05/14/2001, 2001.

**Oil Sands Magazine. 2017.** FROTH TREATMENT EXPLAINED. [Online] Oil Sands Magazine, 2017. <http://www.oilsandsmagazine.com/technical/mining/froth-treatment>.

**Oil-Sands-Magazine. 2017.** PARAFFINIC FROTH TREATMENT. [Online] 2017. <http://www.oilsandsmagazine.com/technical/mining/froth-treatment/paraffinic>.

**Pennwell. 2014.** *Worldwide Refinery Survey*. Tulsa, OK : PennWell Corporation, Tulsa, OK. All Rights Reserved., 2014.

**Petrosonic Sonoro.** [Online] <http://www.sonoroenergy.com/technology/>.

**Rahimi, P., Fairbridge, C. and Tanner , D.D. 1998.** The use of methane as a source of higher hydrocarbons and hydrogen for upgrading heavy oils and bitumen : Prepr. Pap. – Am. Chem. Soc., Div. Fuel Chem., 1998, Vols. 43(3): 476-480.

**Rahimi, P., Parker, R.J. and Wiehe, I.A. 2001.** Stability of visbroken products obtained from athabasca bitumen for pipeline transportation : Prepr. – Am. Chem. Soc. Div. Petrol. Chem., 2001, Vols. 46(2): 95-98.

**Rahmani, S., McCaffrey, W.C. and Gray, M.R. 2002.** Kinetics of solvent interactions with asphaltenes during coke formation : Energy Fuels, 2002, Vols. 16: 148-154.

**Raseev, S. 2003.** *Thermal and catalytic processes in petroleum refining*. New York : Marcel Dekker., 2003.

**Roche, P. Feb 5, 2018.** *Former Syncrude Researcher Sees Oilsands Opportunity for Upgrading Commercialized In China.* Oil Daily Bulletin, Feb 5, 2018.

**Ruchardt, C.M., Gerst, C.M. and Nolke, M. 1992.** Bimolecular formation of radicals by hydrogen transfer. 1. The uncatalyzed transfer hydrogenation of alpha-methylstyrene by dihydroanthracene or xanthene - a radical reaction : *Angew. Chem., Int. Ed. Engl*, 1992, Vols. 31: 1523-1525.

**Sea-Distances.org. 2017.** Blue water 2017. <https://sea-distances.org/>. [Online] 2017. <https://sea-distances.org/>; .

**Seyer, F.A. and Gyte, C.W. 1989.** Viscosity pages: 155-184. [book auth.] L. C. Hepler and C. Hsi. *Aostr technical handbook on oil sands, bitumens, and heavy oils*. Edmonton, AB : AOSTRA, 1989.

**Snamprogetti - Montanari, R. 2005.** *Snamprogetti's Highlights EST Technology*. [Online] Rice Global E&C Forum, 2005. <http://www.forum.rice.edu/wp-content/uploads/roundtables/RT%20031105%20Montanari.pdf>.

**Soebianto, Y.S., et al. 1992.** Protection in radiolysis of n-hexadecane .2. Radiolysis of n-hexadecane in the presence of additives. : *Radiat. Phys. Chem.*, 1992, Vols. 40(6): 451-459.

**Soskind, D. M., et al. 1962.** Fluid coking of heavy resids : *Khimiya i Tekhnologiya Topliv i Masel*, 1962, Vols. 10(October): 5-9.

**Sternberg, H.W., et al. 1974.** Reaction of sodium with dibenzothiophene - method for desulfurization of residua : *Ind. Eng. Chem. Prod. Res. Dev.*, 1974, Vols. 13: 433-436.

**Suslick, K.S., et al. 1983.** Alkane sonochemistry : *J. Phys. Chem.*, 1983, Vols. 87(13): 2299-2301.

**Thompson, L.H. and Doraiswamy, L. K. 1999.** Sonochemistry: Science and engineering : *Ind. Eng. Chem. Res.*, 1999, Vols. 38(4): 1215-1249.

**ThyssenKrupp UMATAC Taciuk. 2016.** <http://www.umatac.ca/>. [Online] 2016. [http://www.umatac.ca/includes/media/downloads/WHOC16-263\\_UMATAC\\_ATP-Process.pdf](http://www.umatac.ca/includes/media/downloads/WHOC16-263_UMATAC_ATP-Process.pdf).

**Topsoe, H., Clausen, B. S. and Massoth, F. E. 1996.** *Hydrotreating catalysis*. Berlin : Springer, 1996.

**TransCanada. 2017.** [Online] 2017. <https://www.transcanada.com/en/operations/oil-and-liquids/keystone-pipeline-system/>.

**Value Creation. 2016.** Presentation to Strathcona County, 2016. [Online] 2016. <https://pub-strathcona.escribemeetings.com/filestream.ashx?DocumentId=5349>.

**Verkade, J.G. and Yu, Z. 1999.** Desulfurization of organosulfur compounds with lithium and sodium : *Energy Fuels*, 1999, Vols. 13: 23-28.

**Vilcaez, J., et al. 2012.** Hydrothermal extractive upgrading of bitumen without coke formation : *Fuel*, 2012, Vols. 102: 379-385.

**Watanabe, M., et al. 2010.** Heavy oil upgrading in the presence of high density water: Basic study : *J. Supercrit. Fluids*, 2010, Vols. 53: 48-52.

**Well Resources. 2018.** SELEX-Asp Selective Extraction of Asphaltenes. [Online] 2018. <https://www.wellresources.ca/selex-asp>.

**Wiehe, 1993.** A phase separation kinetic model for coke formation : *Ind. Eng. Chem. Res.*, 1993, Vol. 32. 2447-2457..

**Wiehe, I. A. and R. J. Kennedy. 2000.** The oil compatibility model and crude oil incompatibility. : *Energy Fuels*, 2000, Vol. 14. 56-59.

**Wiehe, I. A. 2008.** *Process chemistry of petroleum macromolecules Vol 121*. Boca Raton, FL : CRC Press, 2008.

**Xu, S., et al. 1998.** The chemistry, reactivity and processability of athabasca bitumen pitch : *Rev. Process Chem. Eng.*, 1998, Vols. 1: 41-79.

**Yarranton, H.W. and Satyro, M.A. 2009.** Expanded fluid-based viscosity correlation for hydrocarbons : *Ind. Eng. Chem. Res.*, 2009, Vols. 48(7): 3640-3648.

**Yarranton, H.W., et al. 2015.** Density and refractive index of petroleum, cuts, and mixtures : *Energy Fuels*, 2015, Vols. 29(9): 5723-5736.

**Yarranton, H.W., et al. 2013.** On the size distribution of self-associated asphaltene : *Energy Fuels*, 2013, Vols. 27(9): 5083-5106.

**Yuan, B. 2016.** Asphaltenes extraction treatment yields advantaged hydroprocessing feedstock : *Oil and Gas Journal*, 2016.

**Yui, S.M. 1999.** Removing diolefins from coker naphtha necessary before hydrotreating : *Oil Gas J.*, 1999, Vols. 97(36): 64-68.

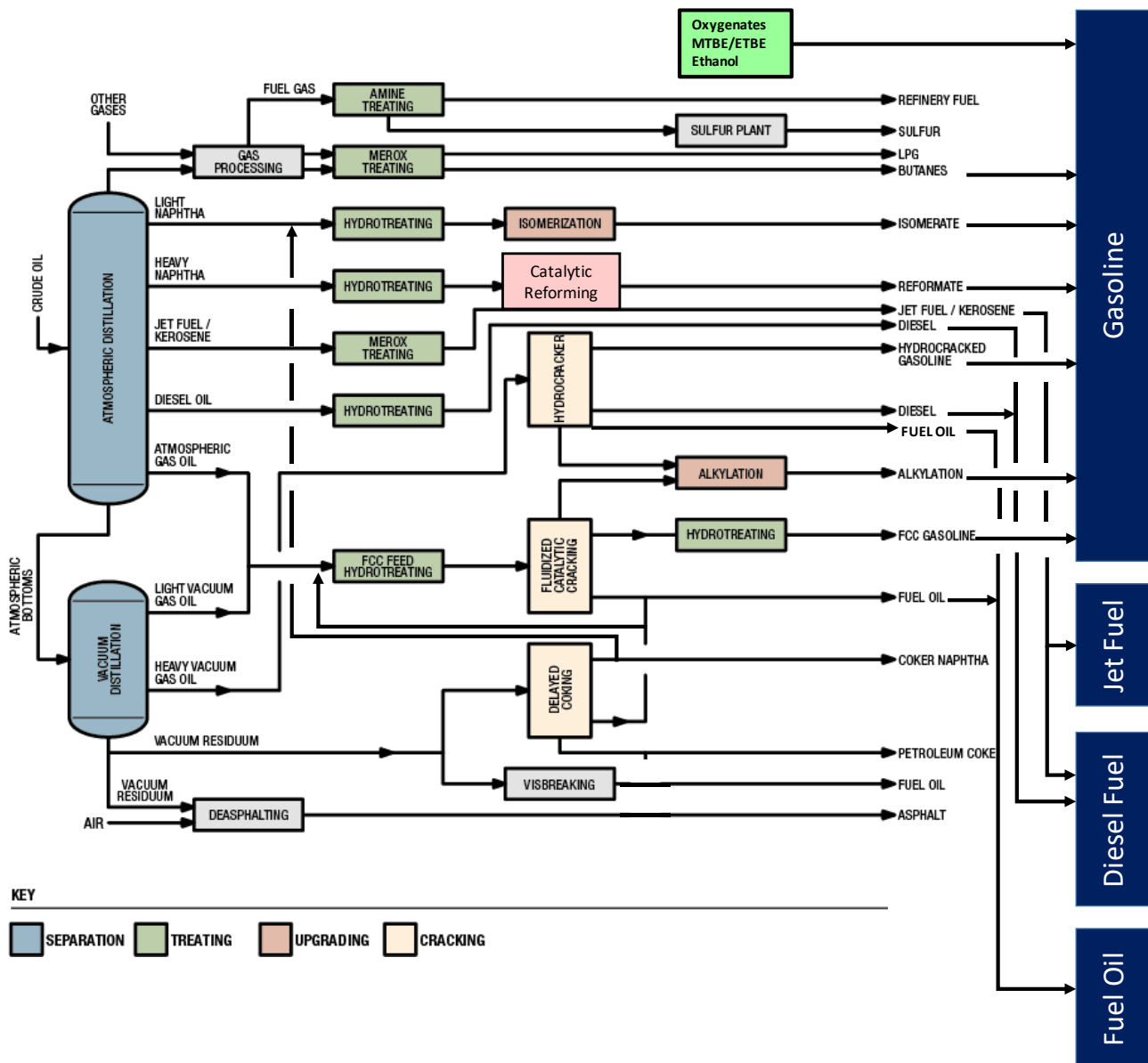
**Zachariah, A. and de Klerk, A. 2016.** Thermal conversion regimes for oilsands bitumen : *Energy Fuels*, 2016, Vols. 30(1): 239-248.

**Zhang, M. 2012.** Role of Bitumen Viscosity in Bitumen Recovery from Athabasca Oil Sands. *MSc Thesis*. Edmonton : University of Alberta, 2012.

## Appendix C: Petroleum Refining

Petroleum refining converts crude oil primarily into transportation fuels. A schematic of a typical refinery in Figure C.1 shows most major processing units used by refineries. The first step is desalting to remove salt and water from the crude oil followed by fractionation of the crude oil into major components: naphtha, distillate, gasoil, and resid. Subsequent steps convert these streams into lighter components or treat them to improve their quality, for example, by removing sulfur and nitrogen, improving octane or cetane, or making other changes to maximize production of the most valuable products.

Figure-C.1: Petroleum Refinery Schematic



Source: MOGAS: with additions/modifications by Jacobs

Individual refineries use a subset of the processing units shown in Figure C.1. Choosing which processing units to incorporate into the refinery depends on the crude oil characteristics and the market for refined products. Figure C.1 shows all the possible processing units available to a refiner. Refineries that process heavy crude oils, including Alberta bitumen, require large amounts of bottoms conversion capacity: vacuum distillation, visbreaking, solvent deasphalting, coking, FCC, and hydrocracking, which are all designed to convert heavy components in the crude oil to light material suitable to make gasoline, jet, and diesel fuels.

The major products from petroleum refining are transportation fuels – gasoline, jet fuel, and diesel fuel. Fuel oil for stationary use and for ships (bunker fuel) is produced from heavy material that the refinery cannot process or upgrade. Petroleum refineries also produce products for the petrochemical industry. These can be propylene, other olefins and diolefins, naphthas, and aromatics. In addition, petroleum refineries produce asphalt for roads and a host of other specialty products.

Transportation fuels from petroleum are increasingly augmented with fuels from other sources. Gasoline is often blended with ethanol, butanol, or other compatible biofuel. Diesel is often blended with biodiesel, a fatty acid methyl ester with methanol (FAME) produced from bio-derived fats and oils or with renewable diesel, a paraffin made from hydrotreating bio-derived fats and oils. Jet fuel can be augmented with renewable jet fuel, which is similar to renewable diesel. Future transportation fuels are likely to include electricity supplied to battery electric vehicles, natural gas, or even hydrogen.

- **Atmospheric Distillation Unit** also called Crude Distillation Unit or CDU—The crude distillation unit fractionates the crude oil feed into straight run naphtha, kerosene, distillate and heavy atmospheric resid. The CDU is a single column with a one or two-stage preflash and a desalter. Fuel gas, C<sub>3</sub>S and C<sub>4</sub>S are sent to the gas plant. Naphtha is sent to the naphtha hydrotreating unit (NHT). Kerosene and atmospheric gasoil go to the DHT (distillate hydrotreating unit). The CDU atmospheric residue bottoms (AR) is sent to the vacuum distillation unit (VDU) for further gasoil recovery.
- **Vacuum Distillation Unit or VDU**—The vacuum distillation unit (VDU) produces vacuum resid, which is sent to a delayed coking unit, and light and heavy vacuum gasoils (VGOs) which are sent to the gasoil hydrotreating Unit (GOHT). The CDU and VDU are heat integrated.
- **Delayed Coking Unit**—The coking unit converts vacuum residue from the VDU into lighter components, fuel gas, C<sub>3</sub> and C<sub>4</sub> paraffins and olefins, naphtha, distillate, gasoils and solid petroleum coke product. The delayed coker consists of several coke drums that

feed a common fractionator. Fuel gas, C<sub>3</sub>s and C<sub>4</sub>s go to the Gas Plant. Naphtha from the coker is routed to the naphtha hydrotreating unit (NHT). The light coker gasoil (LCGO) from the coker is low in cetane number and high in sulfur and requires processing in the distillate hydrotreating unit (DHT). The heavy coker gasoil (HCGO) is further processed in the gasoil hydrotreating unit (GOHT) to achieve the sulfur target. Coke from the delayed coker is routed to sales. The solid coke from this unit can be used as a fuel substitute in power production or cement manufacture or in some cases it is used to make anodes for aluminum production.

- **Visbreaking Unit**—The Visbreaking unit is an alternative processing route to reduce the amount of vacuum residue that must go to fuel oil if there is no delayed coking unit or other bottoms upgrading unit.
- **Gasoil Hydrotreating Unit or GOHT**—The gasoil hydrotreating unit (GOHT) desulfurizes heavy gasoil from the CDU, VDU, and coking units. The level of desulfurization can be set so that the feed to the fluidized catalytic cracking (FCC) unit contains less than 1,000 weight parts per million (ppm) sulfur, which is often sufficient to avoid needing an FCC naphtha hydrotreating unit. The GOHT is a significant user of hydrogen.
- **Hydrocracking**—The hydrocracking unit is a high pressure unit that cracks gasoil and vacuum gasoil to lighter products in the gasoline and diesel range. Distillate range products are often of high enough quality that they can be blended to products with little or no additional processing. Gasoline range material generally needs further processing – heavy naphtha in a catalytic reforming unit and light naphtha in an isomerization unit. Unconverted product from the hydrocracking unit is an excellent low sulfur feed to the fluidized catalytic cracking unit (FCC) or can be blended to fuel oil.
- **Fluidized Catalytic Cracking Unit or FCC**—The FCC unit converts heavy gasoils, vacuum gasoils, and heavy hydrotreated gasoils to lighter products. Light cycle oil (LCO) from the FCC unit is sent to the distillate hydrotreating (DHT) unit. FCC naphtha is sent to gasoline blending if it is low enough in sulfur or it can be treated in an FCC naphtha desulfurization unit. Unconverted oil from the FCC unit (called *slurry oil*) can be blended to fuel oil or recycled to the coking unit to avoid producing fuel oil. The FCC unit consists of a reactor / regenerator, a main fractionator, and a wet gas compressor. Flue gas treating with a third stage separator is generally necessary to meet emission specifications.
- **FCC Naphtha Desulfurization Unit**—The FCC naphtha desulfurization unit removes sulfur from FCC naphtha to meet low sulfur specifications in most modern gasolines. As a result of olefin saturation during desulfurization, there can be significant octane loss.
- **Alkylation Unit**—The alkylation unit reacts C<sub>3</sub> and C<sub>4</sub> olefins with isobutane to produce alkylate for gasoline blending. Purchased isobutane often supplements that produced in the refinery.

- **Oligomerization Unit**—The oligomerization unit combines mainly C<sub>3</sub> olefins but in some cases also C<sub>4</sub> olefins into larger, gasoline range molecules. Product octane is lower than alkylate, the product is olefinic, and there is lower yield than from alkylation because this process reacts two olefins together rather than one olefin with one isobutane molecule. Alkylation and oligomerization units convert LPG range material to gasoline.
- **Naphtha Hydrotreating Unit or NHT**—Naphtha from the CDU, coker, DHT, hydrocracking and GOHT units are hydrotreated in the NHT. The resulting product can be fractionated to send the C<sub>6</sub>/C<sub>7</sub>+ components to the catalytic reforming unit and the C<sub>5</sub>/C<sub>6</sub> components to the isomerization unit. The cut-point between light and heavy naphtha can be set to minimize benzene and its precursors in the feed to the catalytic reforming unit. Depending on the feed and degree of desulfurization, the NHT is a low to moderate user of hydrogen.
- **Catalytic Reforming Unit or Reformer**—The catalytic reforming unit processes heavy naphtha from the naphtha splitter that follows the naphtha hydrotreating unit. The catalytic reforming unit or reformer is the major producer of high octane for gasoline blending. The severity (Research Octane or RON) of the unit is adjusted to meet overall gasoline octane specifications for finished gasoline resulting from blending all gasoline range components. Most of the octane in reformate from the catalytic reforming unit comes from aromatics produced in this process, which results in volume loss due to hydrogen removal in making aromatics. There is also volume loss in catalytic reforming as some naphtha is cracked to gas. The extent of volume loss and gas production depends on the severity that the catalytic reforming unit is operated at: higher severity (RON) results in more octane, hydrogen, and aromatics, but less volume. The catalytic reforming unit is an important source of hydrogen in the refinery.

To meet the benzene limits imposed by gasoline regulations in most countries, the naphtha feed to the catalytic reforming unit can be fractionated in a naphtha splitter to concentrate benzene precursors in light naphtha that can be blended directly to gasoline or processed in a light naphtha isomerization unit. Alternatively, to meet benzene specifications, the reformate product from the catalytic reforming unit can be fractionated to produce light and heavy reformate. Light reformate containing most of the benzene is processed together with the light naphtha from the naphtha splitter in the C<sub>5</sub>/C<sub>6</sub> isomerization unit.

When oxygenates are added in gasoline blending, there is less need for octane from the catalytic reforming unit and more hydrotreated naphtha feed to the catalytic reforming unit can be bypassed around this unit and blended directly to gasoline and/or the severity (RON) of the catalytic reforming unit can be reduced. The result is more gasoline production as a result of adding oxygenates and less processing in the catalytic reforming unit.

- **Isomerization Unit or C<sub>5</sub>/C<sub>6</sub> Isom**—The isomerization unit is a once-through unit that processes light naphtha and light reformate to increase their research octane from the mid-70s to the low-80s and eliminate benzene. If the feed to the isomerization unit exceeds 5 vol% benzene, a separate benzene saturation reactor is used ahead of the isomerization reactor. The isomerization unit uses a small amount of hydrogen to isomerize the C<sub>5</sub>/C<sub>6</sub> paraffins. Isomerization increases the RVP in the product relative to the feed. Three moles of hydrogen per mole of benzene are used to convert benzene to cyclohexane. A depentanizer can be used ahead of the Isom unit to minimize the RVP impact of isomerization.
- **Benzene Saturation Unit**—An alternative to eliminating benzene in an isomerization unit is to simply saturate it in a benzene saturation unit. Because there is no isomerization of C<sub>5</sub>/C<sub>6</sub> paraffins that helps offset the octane loss from benzene saturation, it is necessary to operate the catalytic reforming unit at slightly higher severity than when an isomerization unit is used to eliminate benzene. The net effect is less overall gasoline yield but more hydrogen from the catalytic reforming unit as a result of operating at higher severity.
- **Distillate Hydrotreating Unit or DHT**—The Distillate Hydrotreating Unit (DHT) reduces sulfur in the distillate range material (kerosene and distillate) from the CDU, coker, GOHT units and sometimes from the hydrocracking unit. In addition, the DHT processes light cycle oil (LCO) from the FCC unit to meet ultra-low sulfur diesel (ULSD) specifications. The DHT unit is a significant user of hydrogen.
- **Hydrogen Unit**—Hydrogen is produced in the catalytic reforming unit and in the hydrogen plant, by converting natural gas and/or refinery fuel gas to hydrogen via steam methane reforming. Process heat to the hydrogen plant is supplied by fuel gas supplemented by natural gas as needed. The hydrogen plant includes a pressure swing adsorption unit (PSA) to achieve 99%+ purity hydrogen. Production of hydrogen is particularly greenhouse gas intensive as the byproduct is CO<sub>2</sub>.
- **Merox Treating Unit**—Merox treating units are relatively low cost units that convert or remove mercaptans from LPG, FCC naphtha, and jet fuel. As refined product sulfur levels are reduced to meet clean fuel specifications, Merox treating is not sufficient and it becomes necessary to hydrotreat FCC naphtha and jet fuel.
- **Gas Plants**—Gas plants are designed to achieve high recoveries of C<sub>3</sub>s and C<sub>4</sub>s. Process units include a Primary Absorber, Stripper, Debutanizer, and Amine Treating.
- **Sulfur Plant**—Sulfur is recovered in the sulfur plant from H<sub>2</sub>S that is produced during the refining steps. The sulfur plant consists of a Claus unit, Tail Gas Treating Plant, Amine Regeneration, and Sour Water stripper.

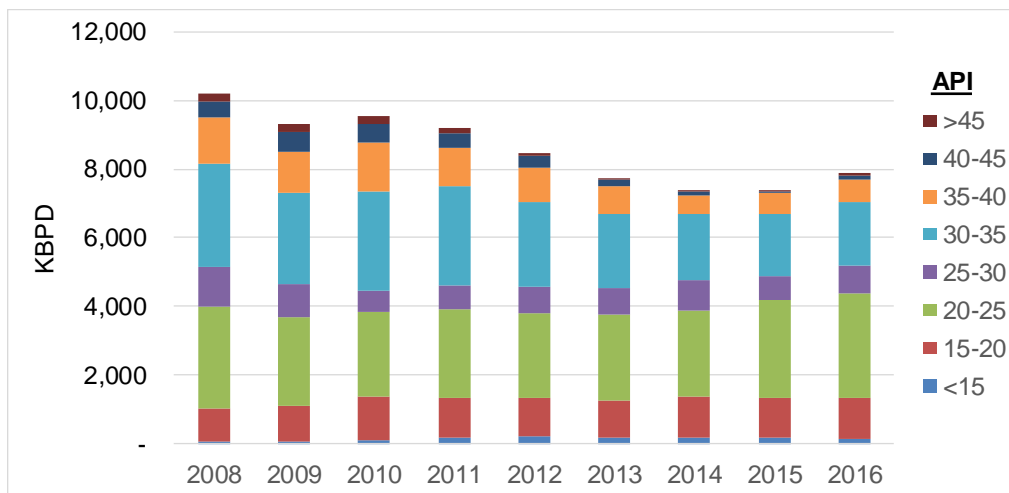


## Appendix D: US Markets for Imported Crude Oil

### Crude Oil Imported into the US

Figure D.1 shows the change in imported crude oil by 5 °API gravity increments. As can be seen in this figure, there has been slow increase in heavy crude oil imports (< 30 API) and a big drop in lighter crude oil imports (>30 API), consistent with the results shown in Figure D.1.

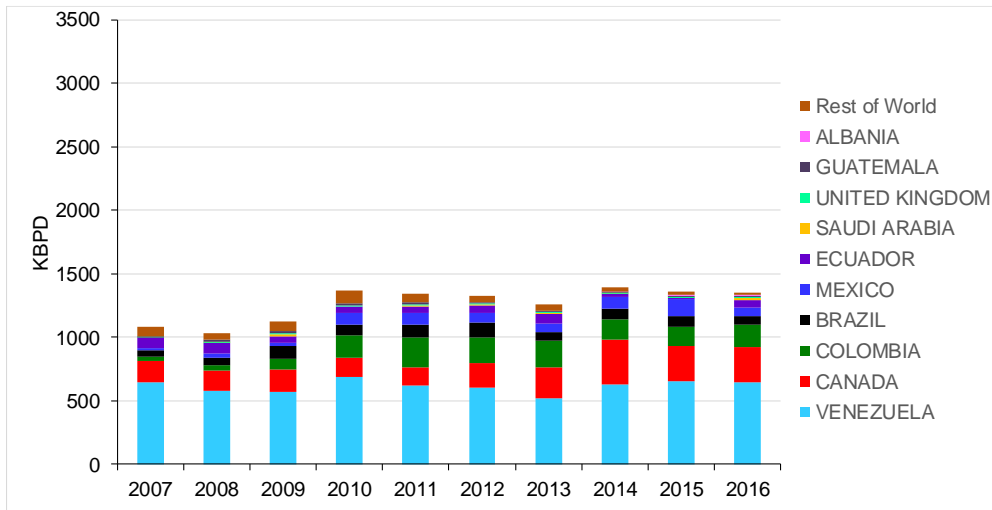
Figure D.1: Trends in API Gravity of Crude Oil Imported to the US



(EIA-9, 2017); Analyzed and plotted by Jacobs

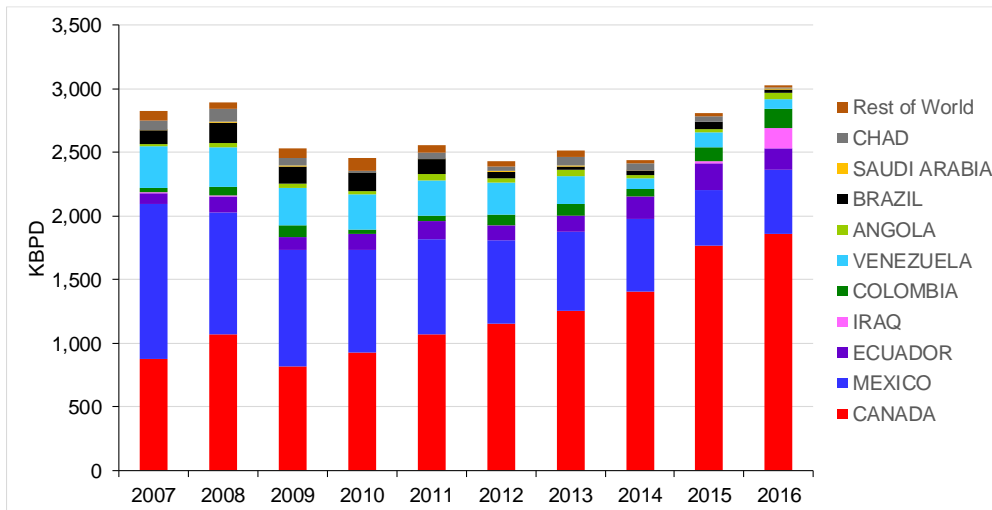
Let us focus on crude oils in the range < 30 API, to better understand US markets for bitumen and partially upgraded bitumen from Alberta. Figures 10.2-10.4 show US import of crude oils with API gravity in the following ranges: < 20, 20-25, and 25-30. Canada is the largest supplier of crude oils in the range 20-25 API and 25-30 API. Venezuela is the largest supplier of crude oils in the range < 20 API. Crude oils in the range 25-30 API are supplied by a number of countries, with Canada as the largest supplier in this range. Pipelines from Canada require Canadian heavy crude oil to be greater than 19 API gravity and less than 350 cSt. To meet this viscosity specification, most heavy Canadian crude oil is a minimum of 20 API gravity.

Figure D.2: US Crude Import < 20 API



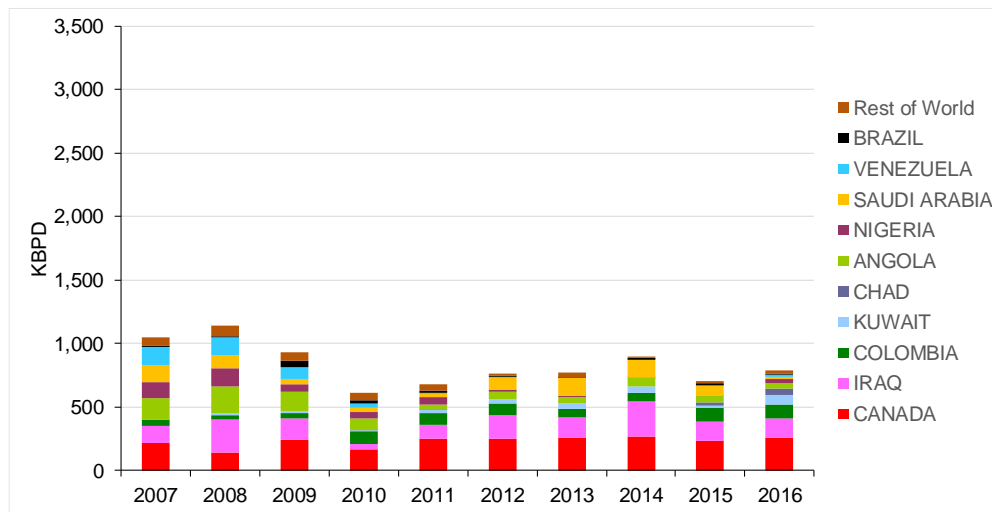
(EIA-9, 2017); Analyzed and plotted by Jacobs

Figure D.3: US Crude Import 20-25 API



(EIA-9, 2017); Analyzed and plotted by Jacobs

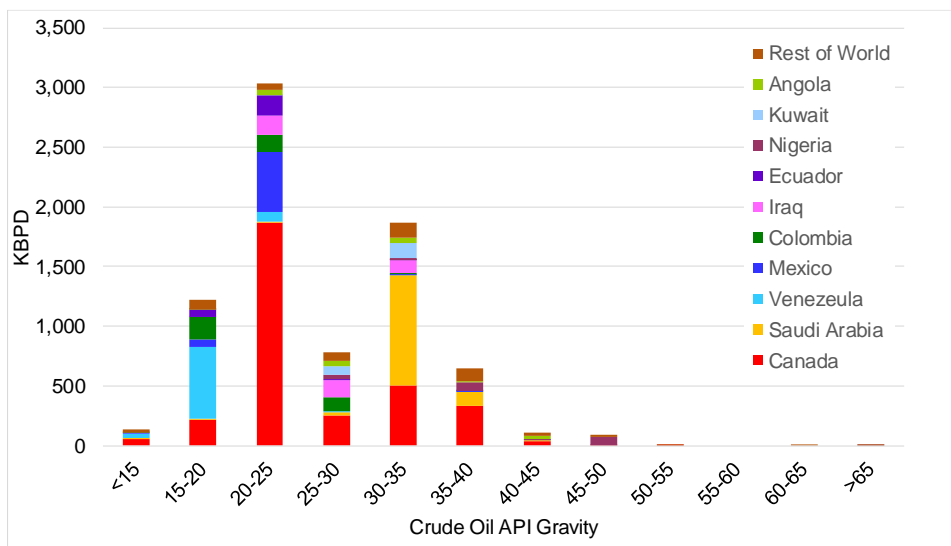
Figure D.4: US Crude Import 25-30 API



(EIA-9, 2017); Analyzed and plotted by Jacobs

Figure D.5 shows the breakdown of all crude oils imported to the US in 2016. Canada was the major supplier to the US of crude oil in the 20-25 API range, which is where most dilbits fall. Mexico is the next largest supplier in this API range. Venezuela is the largest supplier of crude oils in the 15-20 API range. Many SCOs from Alberta fall in the range of 30-40 API gravity.

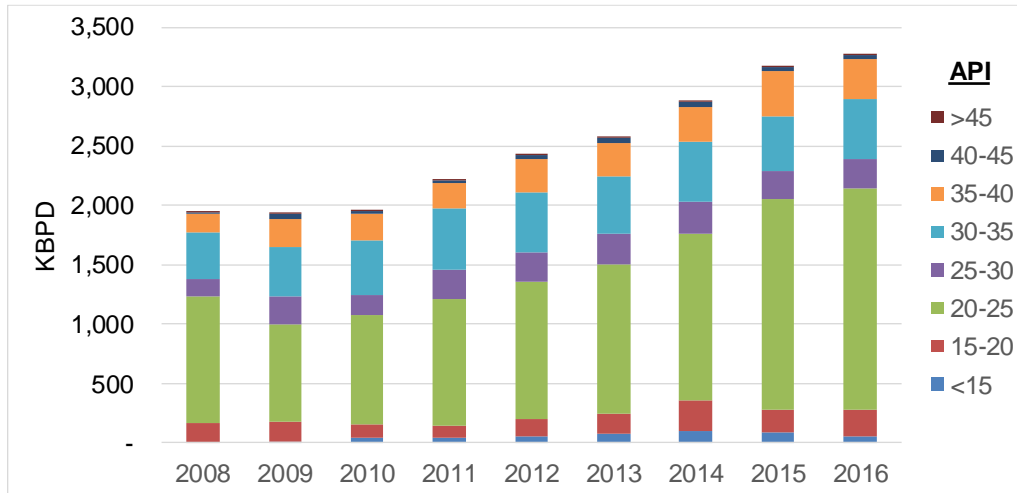
Figure D.5: Crude Oils Imported to the US by API Gravity in 2016



(EIA-9, 2017); Analyzed and plotted by Jacobs

The historical breakdown of Canadian crude oils imported to the US by API gravity is shown in Figure D.6. Growth in US import of Canadian crude oil has been mainly in the range 20-25 API.

**Figure D.6: Canadian Crude Oils Imported to the US by API Gravity**

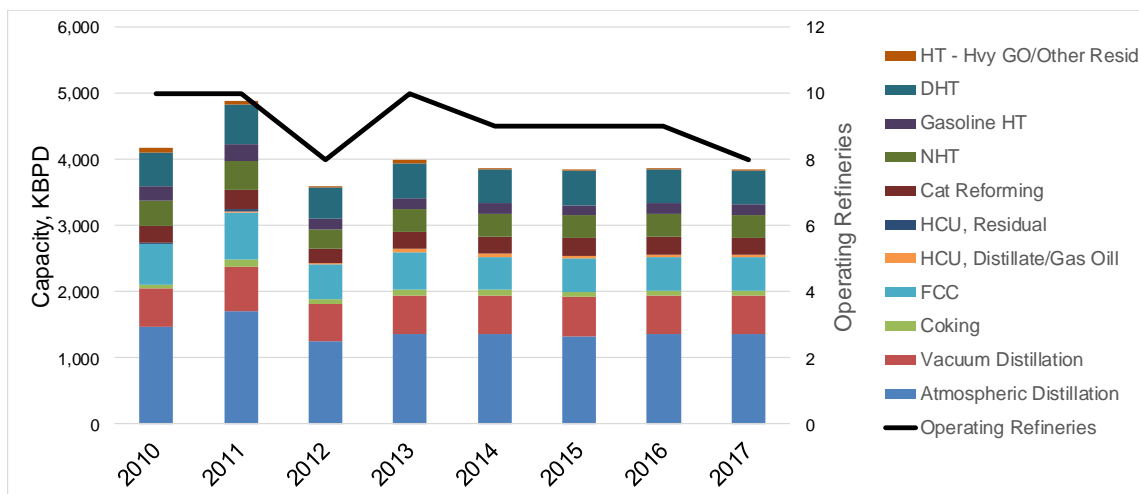


(EIA-9, 2017); Analyzed and plotted by Jacobs

### Crude Oil Imported into PADD1

To better understand markets for Alberta bitumen based crude oils, we will focus on crude oils in the range < 20, 20-25 and 25-30 API gravity imported into different PADDs. First let us look at the refinery processing capability in PADD 1. The number of operating refineries has decreased since 2010 as has crude distillation capacity. This PADD has no coking capacity (Figure D.7).

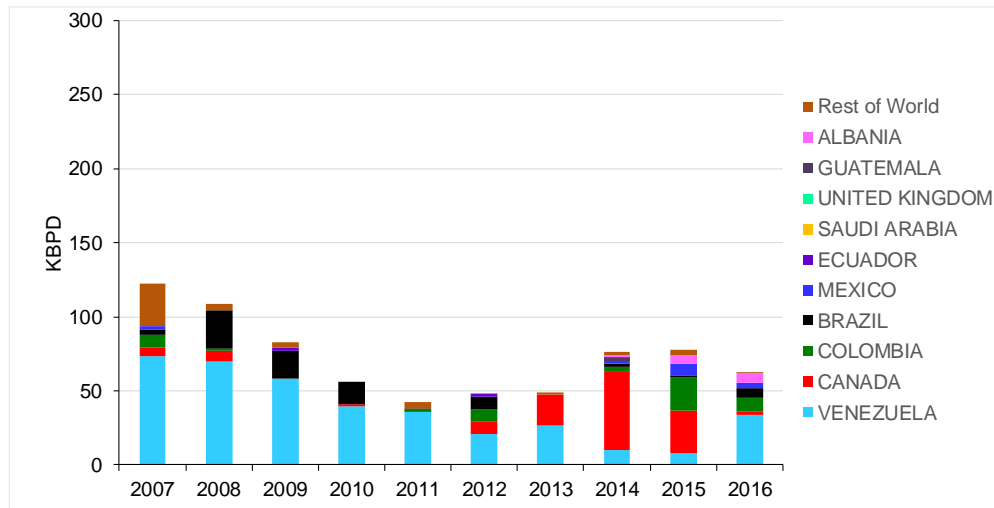
**Figure D.7: PADD 1 Refinery Process Unit Capacity**



(EIA-3 Plotted by Jacobs, 2017)

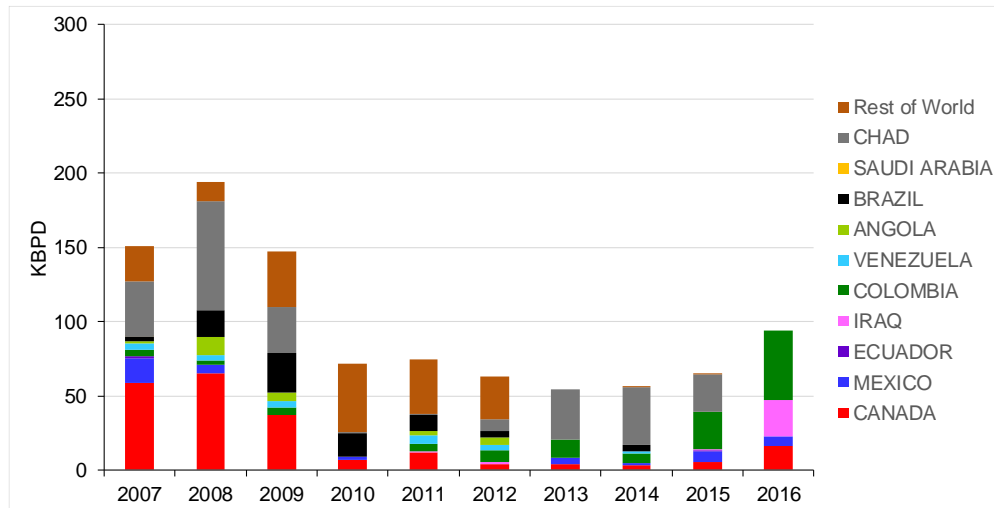
PADD 1 imports a limited amount of heavy crude oils and very little or none from Canada. Figure D.8 shows crude oil imports to PADD 1 < 20 API. Figure D.9 shows crude oil imports to PADD 1 between 20-25 API. Figure D.10 shows crude oil imports to PADD 1 between 25-30 API.

**Figure D.8: Crude Oils Imported to PADD 1 < 20 API Gravity**



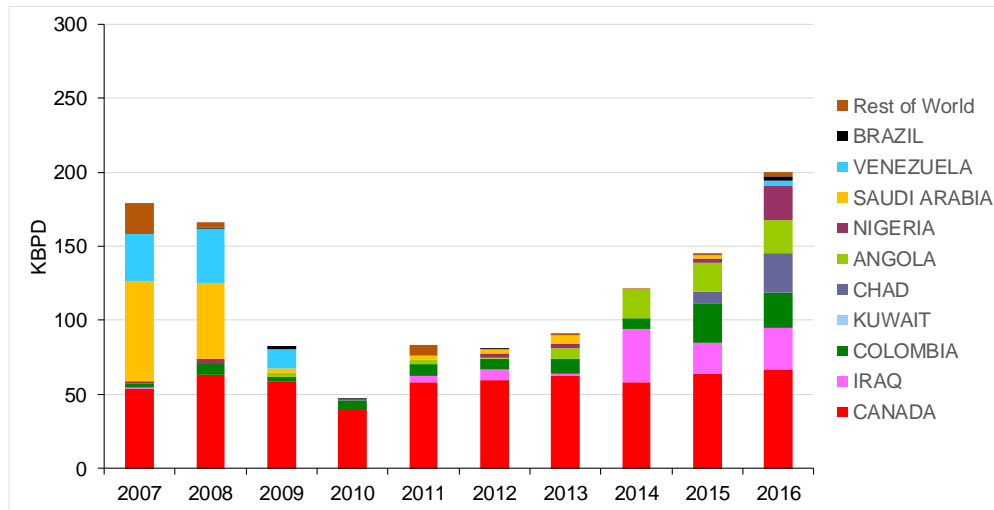
(EIA-9, 2017); Analyzed and plotted by Jacobs

**Figure D.9: Crude Oils Imported to PADD 1 between 20-25 API Gravity**



(EIA-9, 2017); Analyzed and plotted by Jacobs

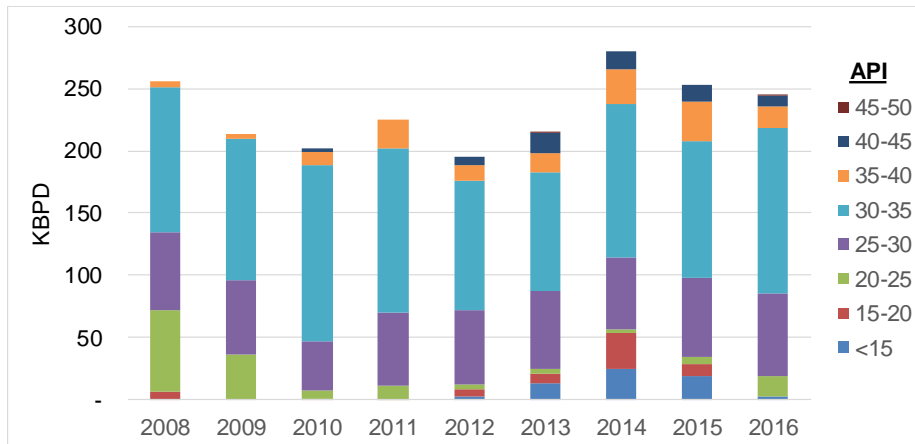
Figure D.10: Crude Oils Imported to PADD 1 between 25-30 API Gravity



(EIA-9, 2017); Analyzed and plotted by Jacobs

PADD 1 has historically not been a market for Alberta heavy crude oils. It is logistically distant from Alberta and lacks bottoms conversion capacity. Most crude oils imported from Canada to PADD 1 are in the range of 30-35 API (Figure D.11) and are from Canada’s east coast.

Figure D.11: Canadian Crude Oils Imported to PADD 1

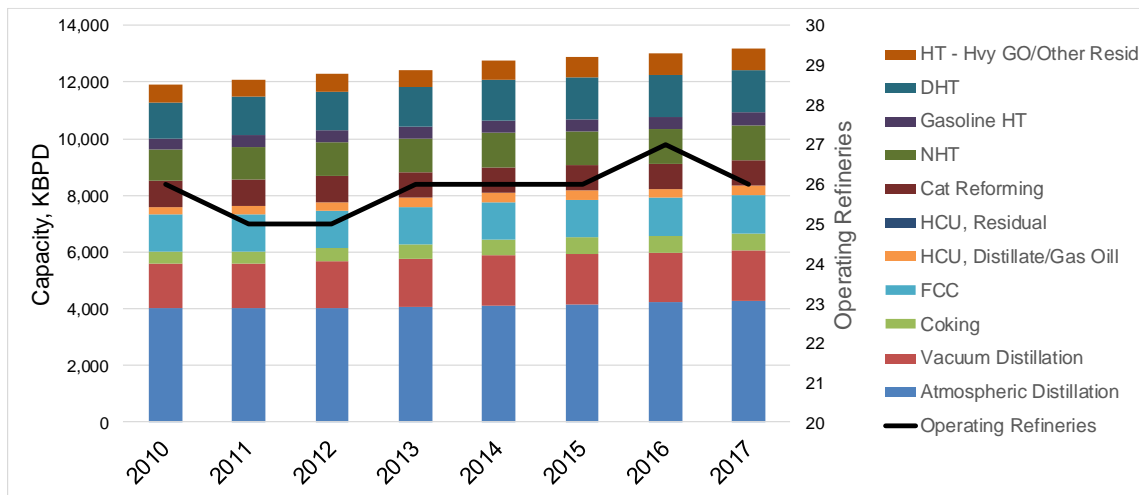


(EIA-9, 2017); Analyzed and plotted by Jacobs

### Crude Oil Imported into PADD2

PADD 2 has seen no increase in crude atmospheric distillation capacity. But has seen small increases in vacuum distillation and coking capacities (Figure D.12).

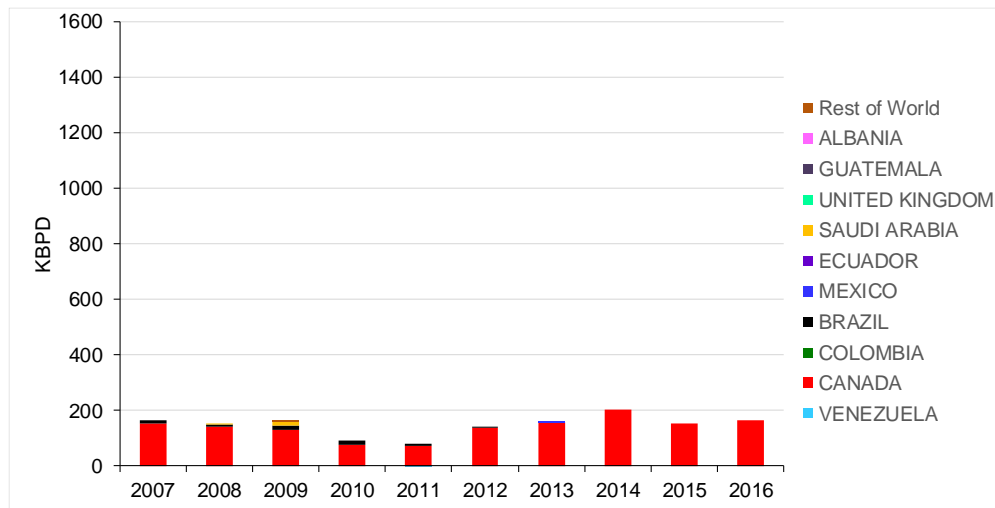
Figure D.12: PADD 2 Refinery Process Unit Capacity



(EIA-3 Plotted by Jacobs, 2017)

Most crudes imported to PADD 2 are from Canada. Figure D.13 shows crudes imported < 20 API, Figure D.14 shows crudes imported between 20-25 API, and Figure D.15 shows crude imported between 25-30 API. PADD 2 has seen little change in imports of crude oil in the < 20 API range. Most of this crude is from Canada.

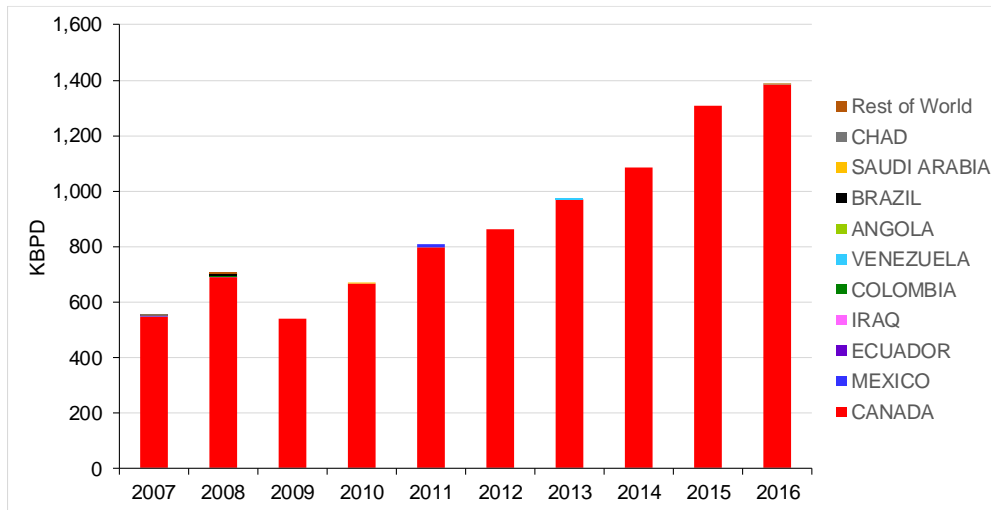
Figure D.13: Crude Oils Imported to PADD 2 < 20 API Gravity



(EIA-9, 2017); Analyzed and plotted by Jacobs

PADD 2 has seen big change in imports of crude oil in the 20-25 API range. Nearly all of this oil came from Canada (Figure D.14).

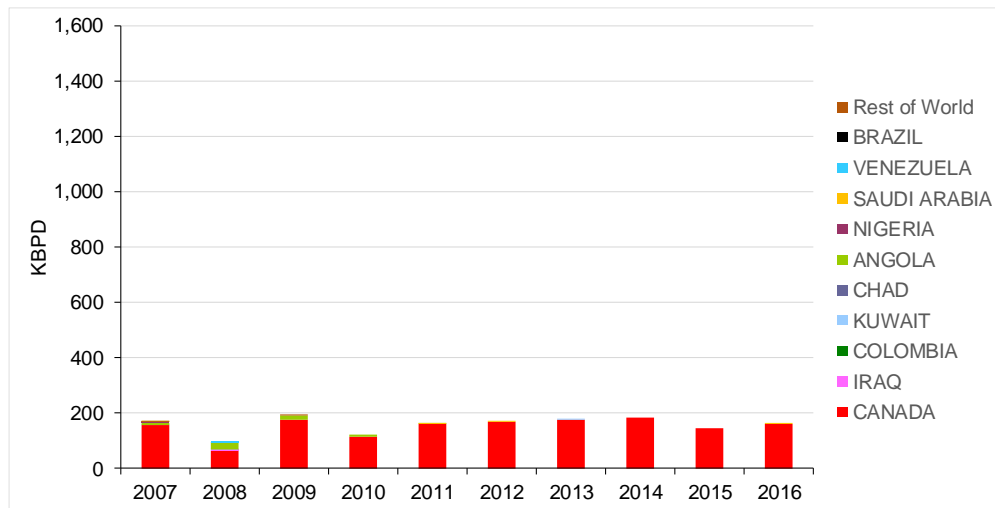
Figure D.14: Crude Oils Imported to PADD 2 between 20-25 API Gravity



(EIA-9, 2017); Analyzed and plotted by Jacobs

PADD 2 has seen a little or no change in imports of crude oil in the range 25-30 API range. Most of this oil came from Canada (Figure D.15).

Figure D.15: Crude Oils Imported to PADD 2 between 25-30 API Gravity

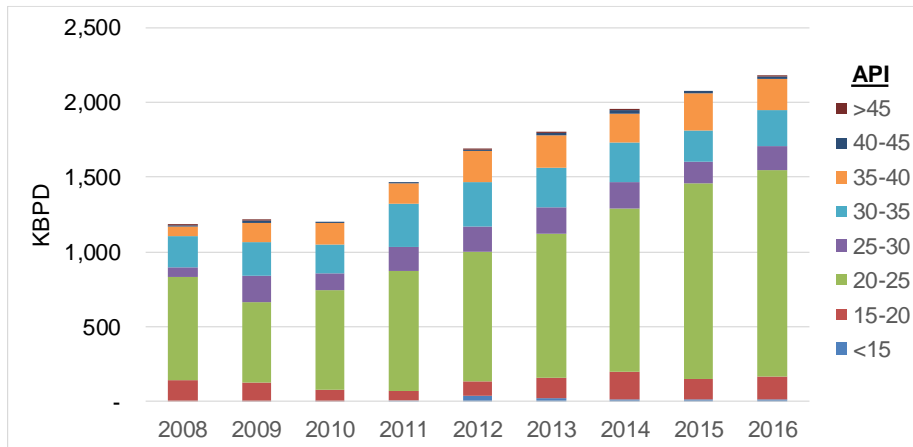


(EIA-9, 2017); Analyzed and plotted by Jacobs

Most of the growth in imports of crude oil from Canada to PADD 2 have been in the 20-25 API gravity range (Figure D.16). The growth in capacity for Canadian heavy crude oil in the 20-25 API range seems to be slowing. Further capacity for this crude oil must be found elsewhere.



Figure D.16: Canadian Crude Oils Imported to PADD 2

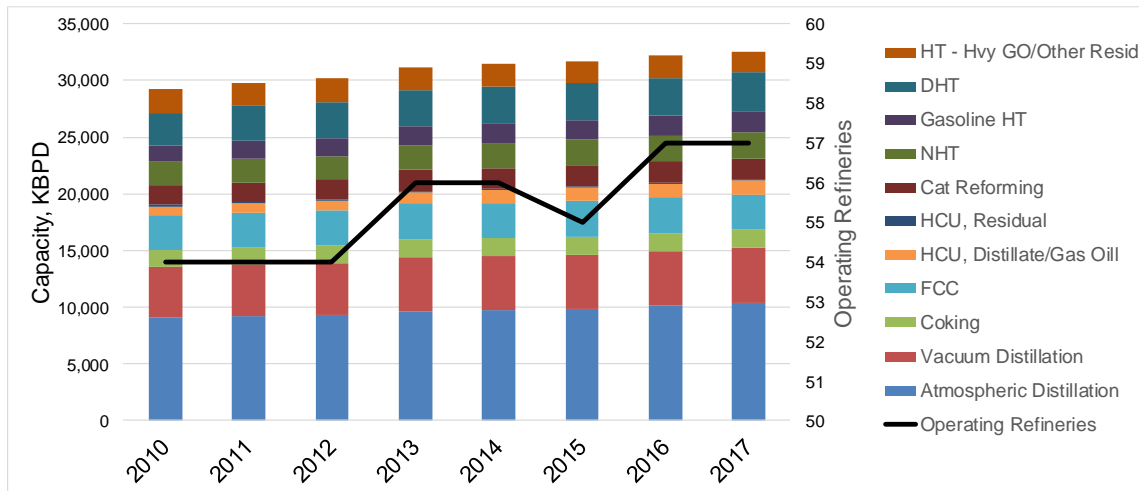


(EIA-9, 2017); Analyzed and plotted by Jacobs

### Crude Oil Imported into PADD3

PADD 3 has seen a small increase in crude atmospheric distillation capacity and a small increase in vacuum distillation capacity and coking capacity (Figure D.17).

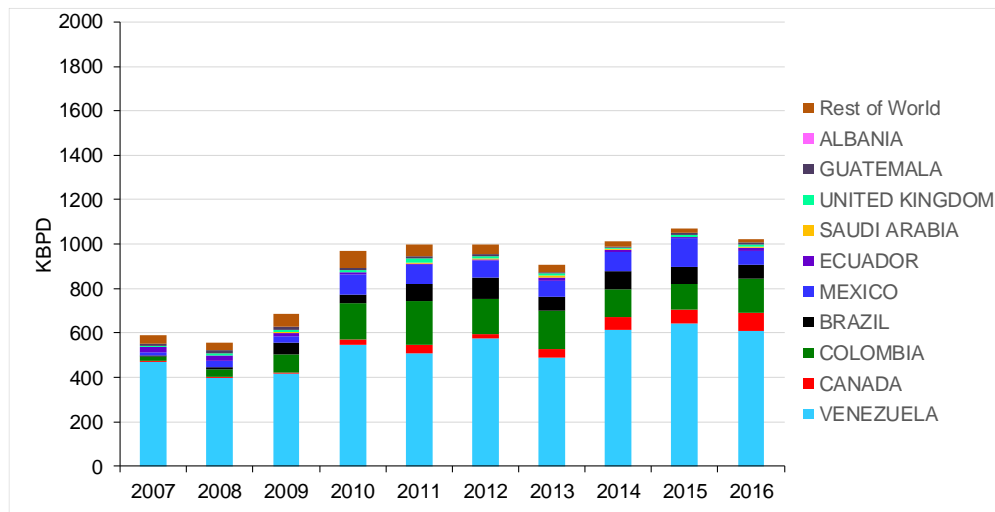
Figure D.17: PADD 3 Refinery Process Unit Capacity



(EIA-3 Plotted by Jacobs, 2017)

PADD 3 has seen little or no increase in imports of crude oil in the range < 20 API range after 2010. Most of this crude oil came from Venezuela (Figure D.18).

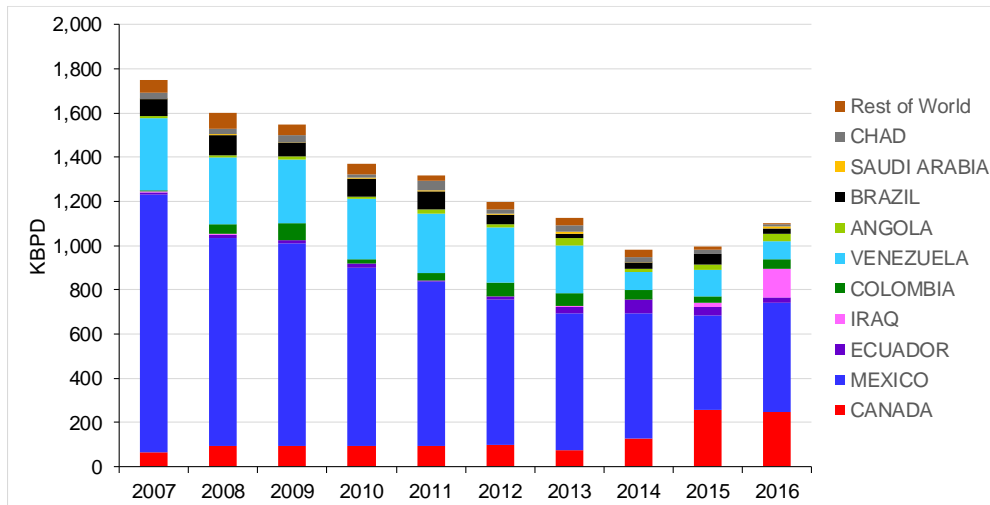
Figure D.18: Crude Oils Imported to PADD 3 < 20 API Gravity



(EIA-9, 2017); Analyzed and plotted by Jacobs

PADD 3 has seen a decline in imports of crude oil in the 20-25 API range. Most of this crude oil came from Mexico. There has been an increase in imports in this API range from Canada, especially since 2014 (Figure D.19).

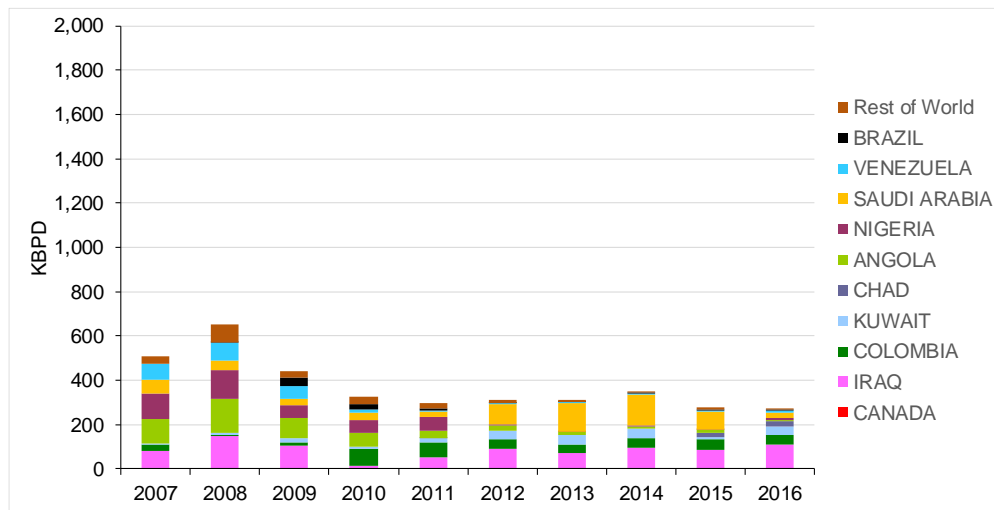
Figure D.19: Crude Oils Imported to PADD 3 between 20-25 API Gravity



(EIA-9, 2017); Analyzed and plotted by Jacobs

PADD 3 has seen a decline in imports of crude oil in the 25-30 API range. This crude oil came from multiple countries (Figure D.20).

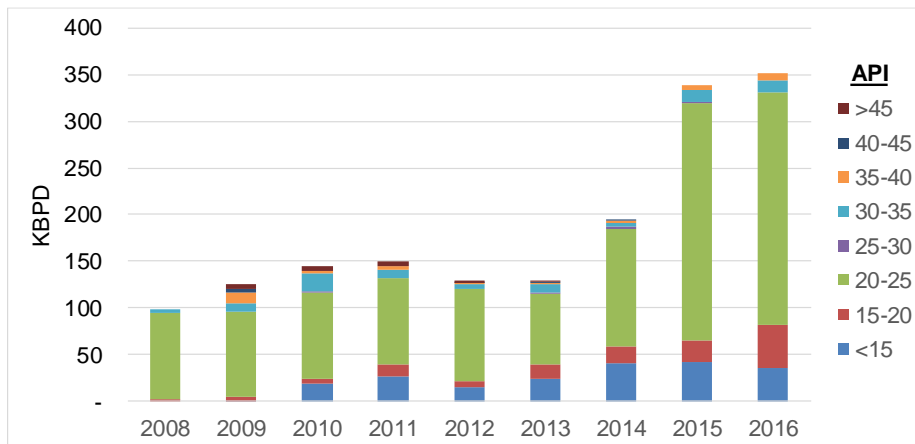
Figure D.20: Crude Oils Imported to PADD 3 between 25-30 API Gravity



(EIA-9, 2017); Analyzed and plotted by Jacobs

Most of the growth in imports of crude oil from Canada to PADD 3 have been in the 20-25 API gravity range (Figure D.21). Growth has increased since 2014.

Figure D.21: Canadian Crude Oils Imported to PADD 3

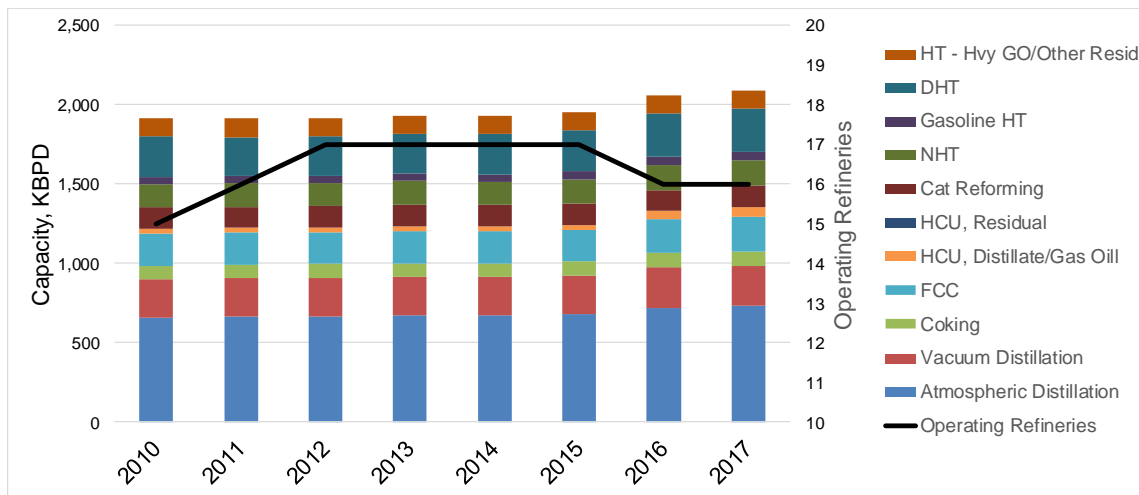


(EIA-9, 2017); Analyzed and plotted by Jacobs

### Crude Oil Imported into PADD4

PADD 4 has seen a small increase in crude atmospheric distillation capacity, a small increase in vacuum distillation capacity, and no increase in coking capacity (Figure D.22).

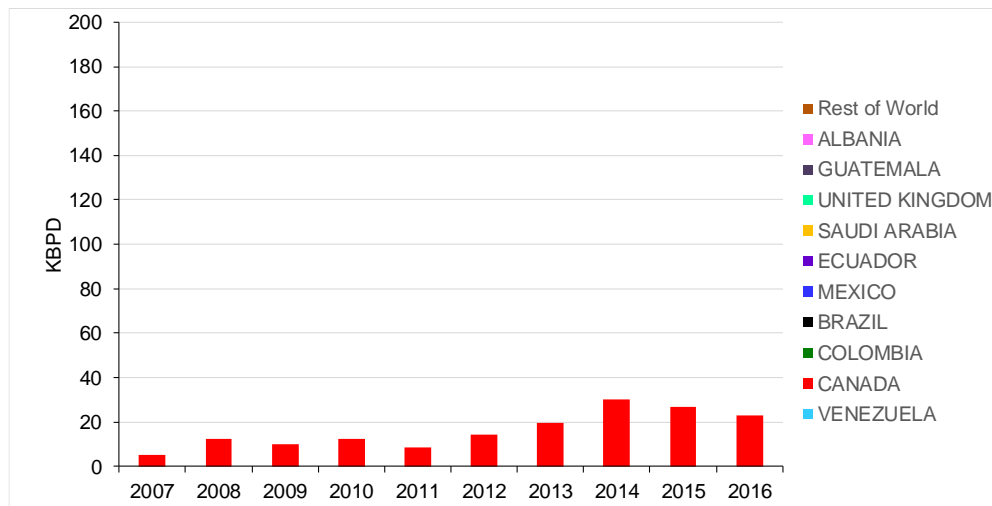
Figure D.22: PADD 4 Refinery Process Unit Capacity



(EIA-3 Plotted by Jacobs, 2017)

PADD 4 imports a small quantity of crude oil from Canada in the range < 20 API (Figure D.23).

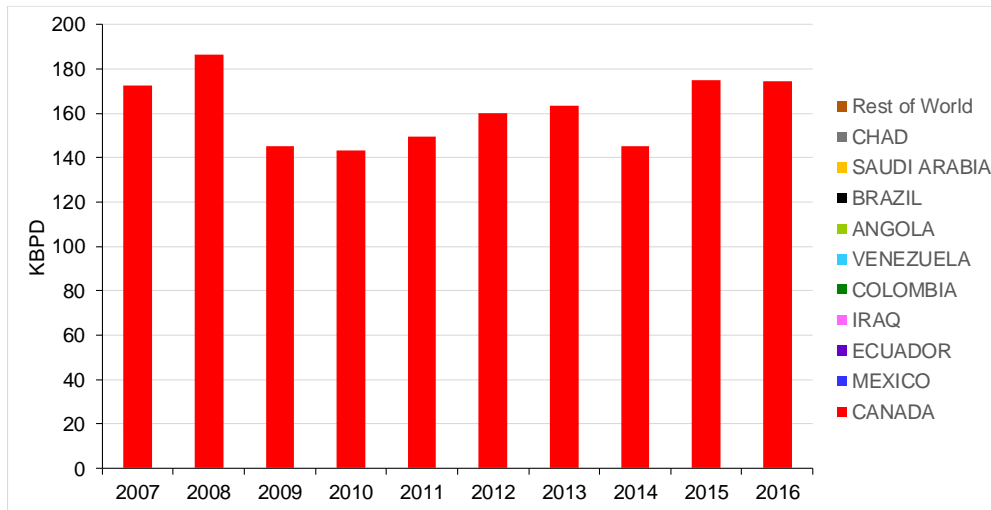
Figure D.23: Crude Oils Imported to PADD 4 < 20 API Gravity



(EIA-9, 2017); Analyzed and plotted by Jacobs

PADD 4 has seen little or no change in imports of crude oil in the 20-25 API range. All of this oil came from Canada (Figure D.24).

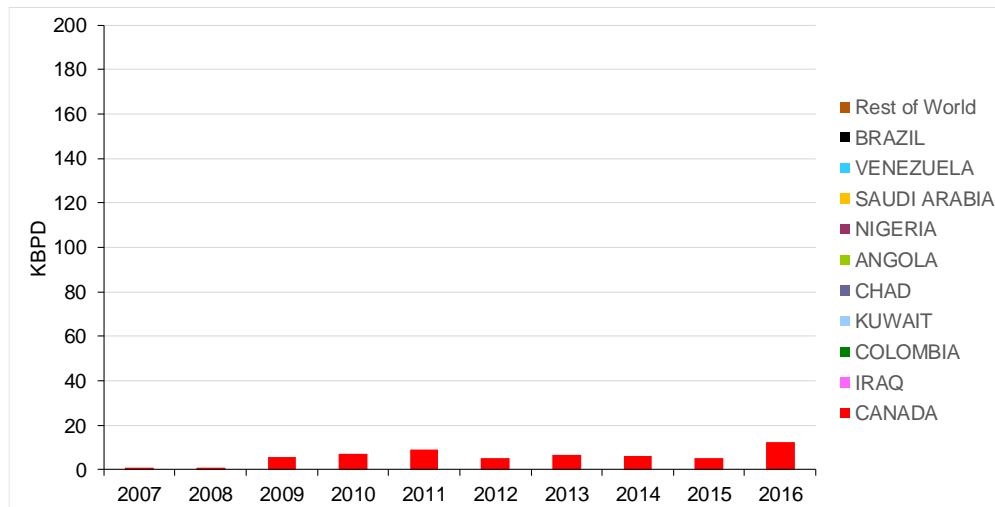
Figure D.24: Crude Oils Imported to PADD 4 between 20-25 API Gravity



(EIA-9, 2017); Analyzed and plotted by Jacobs

PADD 4 imports a small amount of crude oil in the 25-30 API range from Canada (Figure D.25).

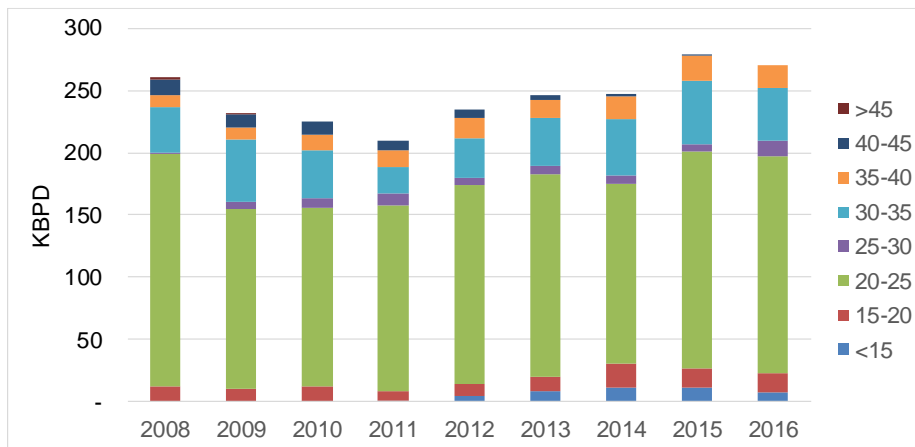
Figure D.25: Crude Oils Imported to PADD 4 between 25-30 API Gravity



(EIA-9, 2017); Analyzed and plotted by Jacobs

There has been little or no increase in imports of crude oil from Canada to PADD 4 Most crude oils are in the 20-25 API range (Figure D.26).

Figure D.26: Canadian Crude Oils Imported to PADD 4

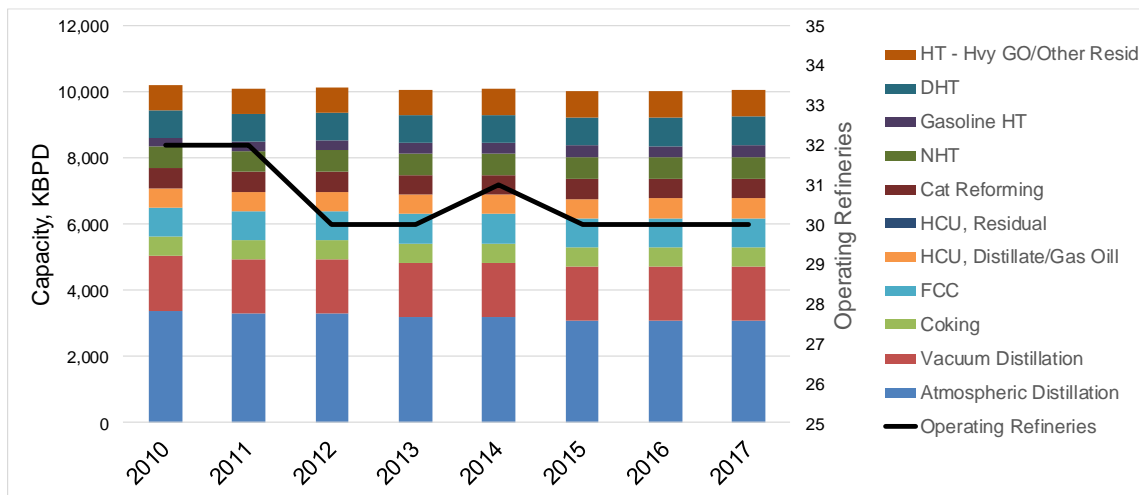


(EIA-9, 2017); Analyzed and plotted by Jacobs

### Crude Oil Imported into PADD 5

PADD 5 has seen a decline in the number of operating refineries since 2010 but very little change in processing capabilities. Crude atmospheric distillation capacity has decreased slightly as has vacuum distillation capacity and coking capacity (Figure D.27).

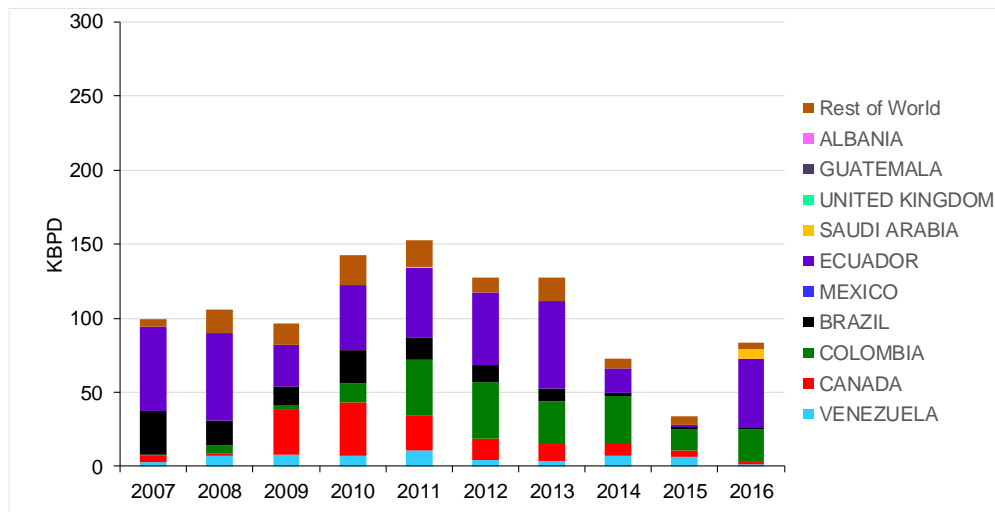
Figure D.27: PADD 5 Refinery Process Unit Capacity



Source: EIA-3 2017– Plotted by Jacobs

PADD 5 has seen a decrease in imports of crude oil in the < 20 API range. The majority of this heavy crude oil is from Ecuador and Colombia; only a small amount is from Canada (Figure D.28).

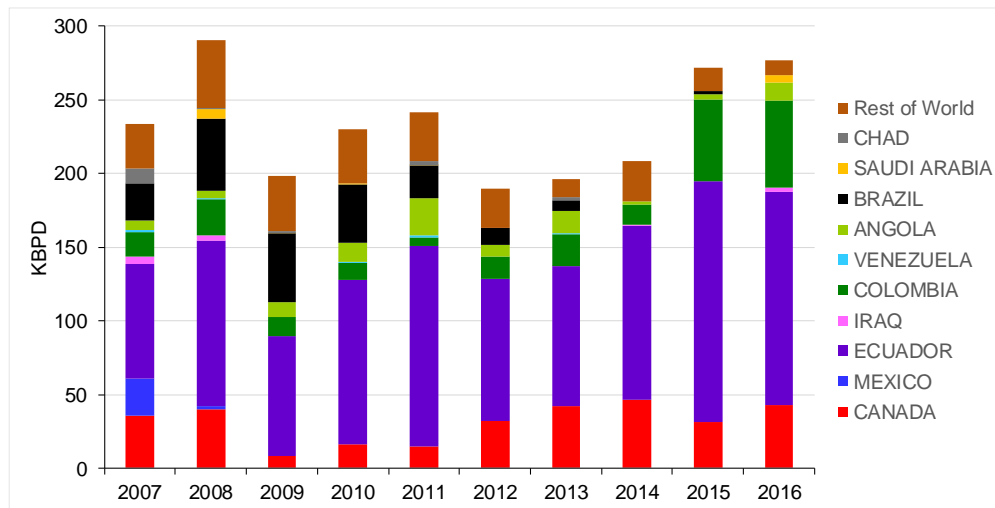
Figure D.28: Crude Oils Imported to PADD 5 < 20 API Gravity



(EIA-9, 2017); Analyzed and plotted by Jacobs

PADD 5 has seen little or no change in imports of crude oil in the 20-25 API range. Most of this oil is from Ecuador; only a small amount is from Canada (Figure D.29).

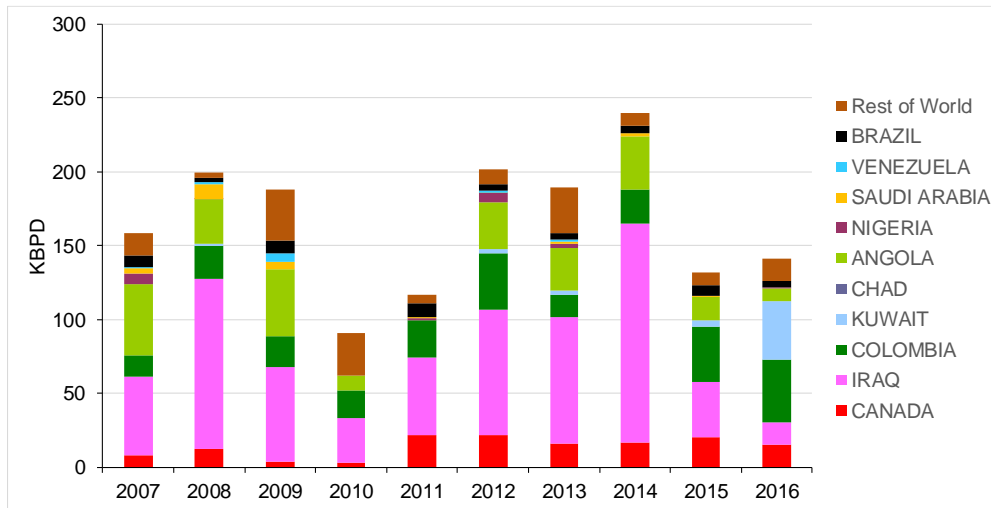
Figure D.29: Crude Oils Imported to PADD 5 between 20-25 API Gravity



(EIA-9, 2017); Analyzed and plotted by Jacobs

PADD 5 has seen little or no change in imports of crude oil in the 25-30 API range. This crude oil comes from a number of countries; very little comes from Canada (Figure D.30).

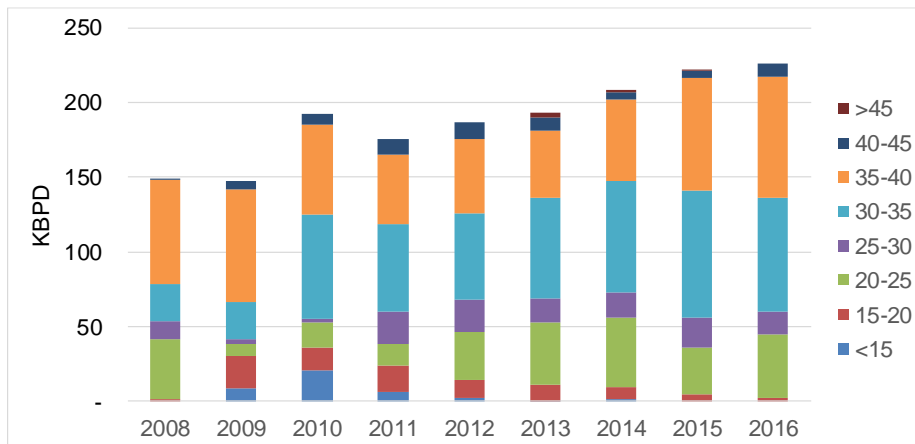
Figure D.30: Crude Oils Imported to PADD 5 between 25-30 API Gravity



(EIA-9, 2017); Analyzed and plotted by Jacobs

Most of the growth in imports of crude oil from Canada to PADD 5 have been in the 30-40 API gravity range (Figure D.31).

Figure D.31: Canadian Crude Oils Imported to PADD 5



(EIA-9, 2017); Analyzed and plotted by Jacobs

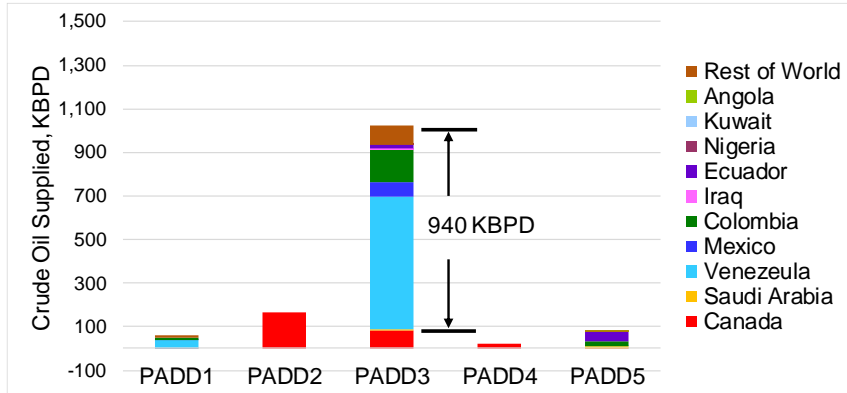
CAPP and AER both project that by 2030, bitumen production in Alberta will increase by around 1.3 MM BPD. This bitumen shipped via pipeline as dilbit will be in the 20-25 API gravity range.

Access to the US market means displacing crude oil supplied by other countries. PADD 1 has little or no access to heavy oil from Alberta and no capacity to refine this crude. PADD 5 has the conversion capacity to process heavy crude oils, but access to heavy crude oil from Alberta is



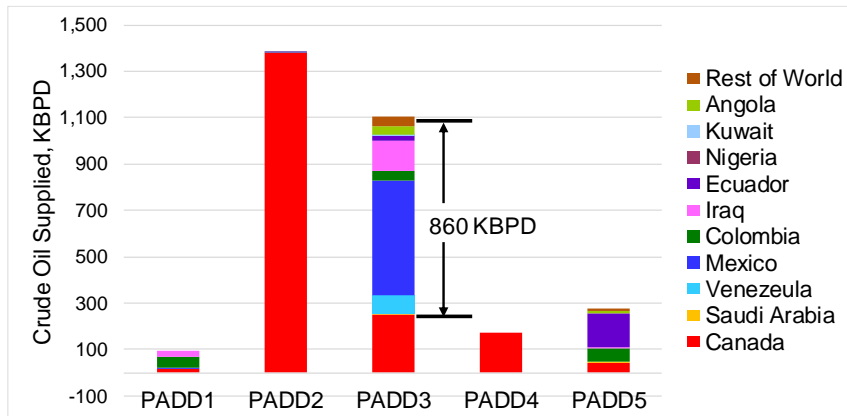
limited. Further, California is well supplied by its own heavy crude oil, and refiners will incur costs if greenhouse gas emissions from refining heavy crude oils increase. PADDs 2 and 4 are fully supplied with crude oil from Alberta. Only PADD 3 has potential room for Alberta heavy crude oil. Figures 10.32-10.35 show the import of crude oils into US PADDs by API gravity in 2016 and the potential crude that could be displaced in PADD 3 by Canadian crude oil.

Figure D.32: 2016 Imports of < 20 API Crude Oil



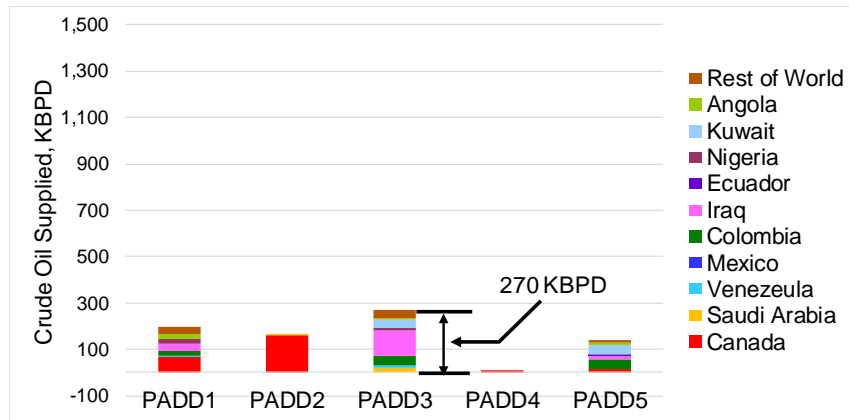
(EIA-9, 2017); Analyzed and plotted by Jacobs

Figure D.33: 2016 Imports of 20-25 API Crude Oil



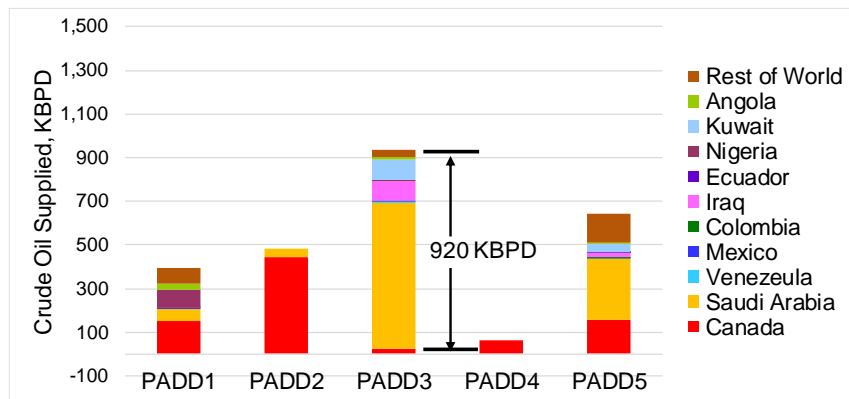
(EIA-9, 2017); Analyzed and plotted by Jacobs

Figure D.34: 2016 Imports of 25-30 API Crude Oil



(EIA-9, 2017); Analyzed and plotted by Jacobs

Figure D.35: 2016 Imports of 30-40 API Crude Oil



(EIA-9, 2017); Analyzed and plotted by Jacobs

The quantity of crude oil that could potentially be displaced in PADDs 3 and 5 by Canadian crude oil are shown in Table 10.1. These results are based on 2016 import volumes.

Table 10.1: Potential Crude Oil Displacement by Alberta Crude Oils

		Crude Oil API Range			
		< 20	20-25	25-30	30-40
PADD3	KBPD	940	860	270	920
PADD5	KPBD	80	230	130	490

Most crude < 25 API is from Venezuela and Mexico and could be replaced by dilbit or partially upgraded bitumen. Crude oil 25-40 API is primarily from Ecuador, Colombia, Iraq, and Saudi Arabia and could be replaced by SCO from a full bitumen upgrading operation. However, adding

new full bitumen upgrading capacity in Alberta is expensive and not planned at this time. Also, consider that dilbit is around a 30/70 mixture of condensate (API gravity ~65) and bitumen (API gravity ~ 8-12). The US is awash in condensate as a result of fracking to produce natural gas and light tight crude oil. Diluent removed from imported dilbit will compete with this US domestic condensate. Demand for non-Canadian crude oil < 20 API in PADD 3 was 940 KBPD in 2016. Demand for this range of crude in PADD 5 was 80 KBPD. For these markets to be open to Canadian crude oil, either the pipeline specifications must be relaxed or it must be transported by rail.

The US market for refined products is projected to shrink by 2030 according to the EIA, and discussed above. US refineries, especially in PADDs 3 and 5 have ready access to crude oils that can be delivered via blue water transport (large tanker ships). PADDs 3 and 5 will be challenged to absorb the 1.3 MM BPD of additional bitumen projected to be supplied by Alberta by 2030. PADDs 2 and 4 are fully supplied by Canada and there are no imports of heavy crude oil from other countries to these PADDs. Without significant, expensive refinery investment, there is not much room for additional heavy Alberta crude oil in PADDs 2 and 4. If the additional heavy crude oil from Alberta cannot be placed in PADDs 3 or 5, it will have to find other markets or be upgraded to better fit the existing US refinery configurations.

## Appendix E. Hydrogen Addition Upgrading Processes

A number of processes have been developed to allow refineries to gain high conversion of vacuum residue to distillable products by combining cracking with hydrogenation reactions. These commercial processes are focused on conversion of vacuum residue and removing sulfur, and they give products that exceed the pipeline specifications and fall outside the definition of partial upgrading. Consequently, these processes are listed here as background information.

Adding hydrogen during upgrading leads to greater volumetric yield and higher quality products. Several residue hydrotreating/hydrocracking technologies have been commercialized. These technologies are complex and have high capital cost. Products are much higher quality than necessary to meet minimum pipeline specifications.

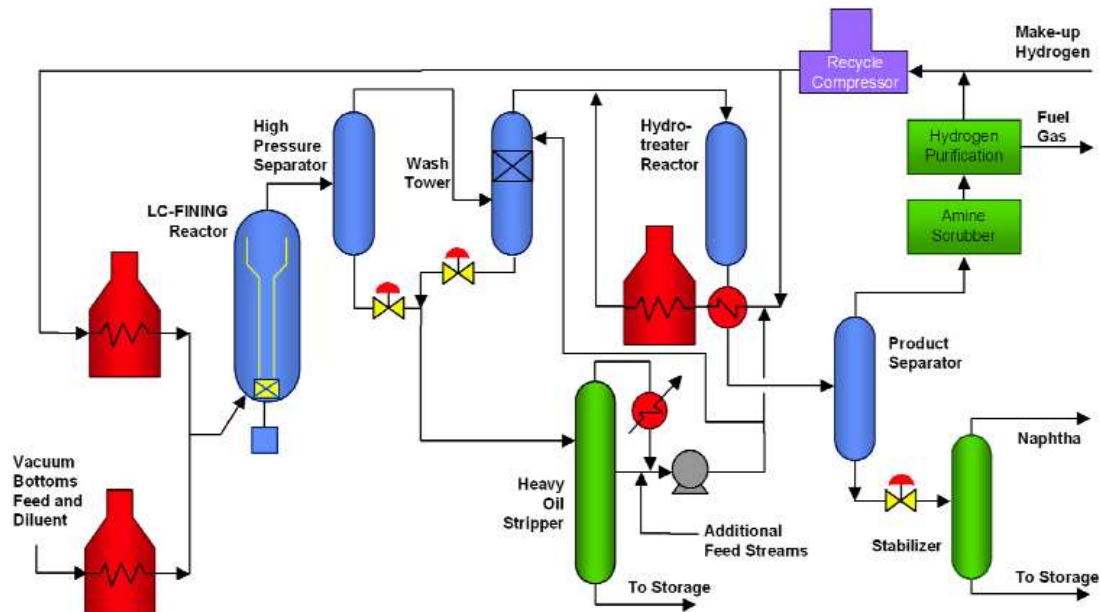
### Ebullated Bed Hydrocracking

Ebullated bed residue hydrocracking converts residue in an ebullating bed of catalyst in the presence of hydrogen at elevated temperatures and pressures. The heaviest portion of residue is cracked to light and heavy vacuum gasoils (LVGO and HVGO), distillate and naphtha. Light fuel gas is produced as a reaction byproduct. As a result of cracking with hydrogen, aromatic chains are saturated as are olefins. Contaminants like metals, sulfur, and nitrogen are removed. This process produces a heavy byproduct that contains some unreacted refractory carbon.

Ebullated bed residue hydrocracking units can upgrade atmospheric and vacuum resid. Two versions are licensed commercially by technology suppliers: LC-Fining from Chevron Lummus Global and H-Oil from Axens.

Figure E.1 shows the schematic for a typical ebullating bed hydrocracking unit (shown here as LC Fining). Process flow in the reactor is upflow to ebullate the catalyst. These reactors act more like a stirred tank reactor and conversion is lower than in a plug flow reactor, which is more typically used in hydroprocessing/hydrotreating of lighter materials less prone to bed plugging. It is necessary to operate residue hydrocrackers in ebullated bed mode to avoid plugging with feed and product contaminants, especially asphaltene agglomerates formed as a result of reacting molecules that solubilize asphaltenes.

Figure E.1: LC Fining Schematic



(Baldassari, et al., 2012)

Ebullating bed residue hydrocracking is currently used in bitumen upgrading at the Husky Bi-Provincial Upgrader, Syncrude and Shell Scotford. A fourth unit is under construction at the Sturgeon refinery (North West Redwater Partnership).

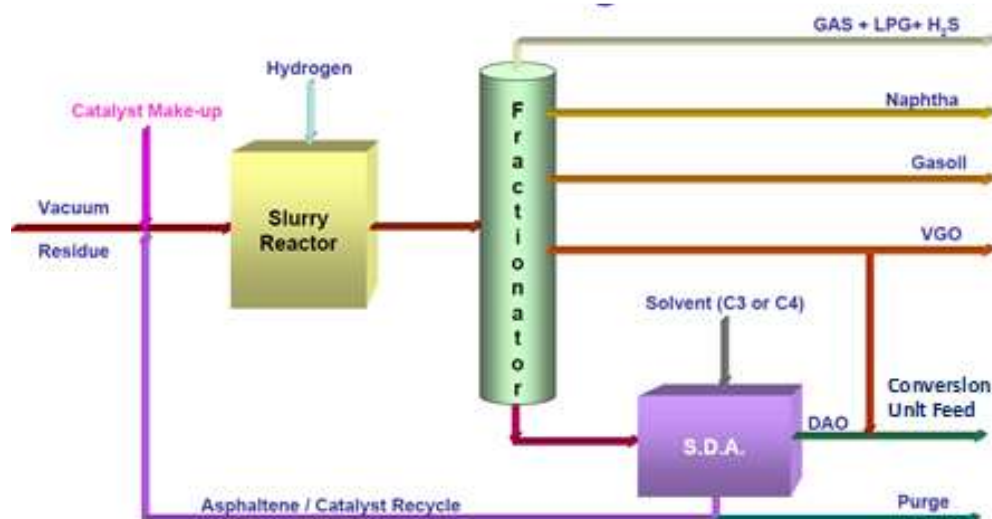
### Slurry-Phase Residue Hydrocracking

Slurry-phase residue hydrocracking uses a dispersed molybdenum based nano-catalyst (molybdenite,  $\text{MoS}_2$ ) or other low cost catalyst to effect hydrocracking of resids. Spent catalyst is removed with the unreacted bottoms. Catalyst cost is low and withdrawal and make up rates are low. Because of the small size of the catalyst, molecular diffusion to catalyst active sites is less of an issue than with ebullating bed residue hydrocracking.

Slurry phase hydrocracking operates at high pressure (1,500-2,000 psig) and temperature (700-850 °F). As a result of catalyst circulation, coking tendencies are reduced. Slurry bed processes are designed to handle residue with high dirt, asphaltenes, and wastes because these processes use very fine particles of catalyst to reduce bed plugging and keep the pressure drop in the reactor section low. Because these processes improve contact with feed, they are reported to achieve upwards of 90% conversion. A fixed bed reactor is often used after the slurry reactor to further treat the reaction products. It can be difficult to operate a slurry reactor because the catalyst tends to accumulate in the reactor section, leading to the plugging of downstream equipment.

In slurry-phase hydrocracking, heavy residue from the vacuum distillation unit is processed in the slurry bed to upgrade and convert the residue to heavy gasoils, distillates, and naphtha. Fuel gas containing H<sub>2</sub>S is a byproduct that goes to the gas plant. The conversion level in the reactor is controlled to maintain stability of the unconverted material and avoid precipitation of asphaltenes. Figure E.2 shows a simple schematic of the reactor and product separation. A solvent deasphalting unit is required when processing vacuum residue from bitumen.

Figure E.2: Slurry Phase Hydrocracking Flow Scheme



(Snamprogetti - Montanari, R., 2005)

A number of licensors offer slurry phase residue hydrocracking: Veba Combi-cracking (VCC) by KBR; ENI's slurry technology (EST); and UOP's Uniflex technology (originally from CANMET). ENI's 23,000 BPD EST unit has been commissioned at the ENI refinery in Sannazzaro, Italy. The Veba-Combi cracking unit was demonstrated at 3,500 BPD at the BP refinery in Gelsenkirchen, Germany. The CANMET slurry phase hydrocracking process was demonstrated in a 5,000 BPD commercial demonstration unit at the PetroCanada Montreal refinery.

ENI has processed Athabasca bitumen in their demonstration unit and found it necessary to process the recycle stream from the fraction system in a solvent deasphalting (SDA) unit to recover heavier gasoils, improve yield, and reduce recycle. Adding an SDA unit concentrates metals and spent catalyst in the pitch (bottoms) from the SDA unit for purge. ENI has not tested slurry phase hydrocracking at the minimum conditions needed to generate a partially upgraded bitumen that meets but does not exceed pipeline specifications.

## Support Units for Residue Hydrocracking

Residue hydrocracking requires the following support units if used in partial upgrading:

- Upstream crude and vacuum distillation
- Amine plant
- Sulfur recovery
- Sour water plant
- Hydrogen production
- Offsites and storage
- Catalyst addition and removal; recovery and disposal

## Summary – Hydrogen Addition

As a result of hydrogen addition, the quality of products from residue hydrocracking is higher than from thermal cracking and there is greater volume yield. However, limitations on conversion because of the need to keep asphaltenes from precipitating, often results in unconverted oil containing refractory carbon. Both ebullating bed and slurry phase hydrocracking require close attention to feedstock composition to maintain operating conditions that avoid asphaltene agglomeration. Residue hydrocracking is a complex process that yields products that exceed the definition of partial upgrading. Although new processes based on these commercial technologies could conceivably be developed to operate at lower conversions to meet pipeline specifications, they are likely to be too expensive for partial upgrading.